



CATALOGUE 2024





Our company and team

Established in 1992, Buki France is today a key player on the toy market. Our mission? Offering educational toys so that children can learn and have fun at the same time! In our French offices, we work on the conception and development of the different products that are released every year.



Our products

BUKI is specialized in scientific toys and arts & crafts kits for children of all ages. Our sets will encourage children to develop their curiosity and their creativity! Our kits are aimed at every child: little ones with products that offer an initiation to science, colours, shapes, time and logic; and older ones with scientific kits and creative toys.



In the world

Buki toys are not only distributed in France, but also in many countries inside and outside Europe, such as Belgium, Spain, Italia, Romania, Bulgaria or Switzerland, Canada or most of the Latin American countries. Our goal? Proposing our toys all over the world by establishing a relationship of trust with our commercial partners.

SUMMARY

Mini Lab.....	4	Dinos & archaeology.....	53
Chemistry.....	8	Mini Sciences.....	60
Experimental Kits.....	11	Buki Junior.....	63
Human body & anatomy.....	16	Cook Chef.....	68
DIY.....	17	Professional Studio.....	69
Electricity.....	19	4 all kids.....	81
Robots construction.....	21	Be Teens.....	84
Microscopes.....	29	Mazes & Marbles.....	106
Space.....	33	Magic.....	109
Science PLUS.....	39	Impulse.....	110
Nature.....	43	Board games.....	110

Legend:

the majority of our products are available in 6 languages:



Recommended age



USB cable included



Battery information



Outer/Inner



Main plug included

ref.in italics = while stocks last

MINI LAB Solar energy

3016

Assemble the parts of the car with the screwdriver, and then make it move with solar energy.

8+



INCLUDES
STEP-BY-STEP
ASSEMBLY
INSTRUCTIONS



BUILD
YOUR OWN
SOLAR CAR



MINI LAB Crystal

3006BLU

A kit for growing a large, colourful crystal easily.

Includes the crystal powder, the growing beaker and illustrated colour instructions.

8+



GROW YOUR
OWN CRYSTAL



MINI LAB Sticky Slime

3007

A kit for making slimy mixtures safely. 6 activities, including slime, bouncy ball, fart paste...

Includes 6 slime powder sachets and instructions illustrated in colour for the activities.

8+



6
ACTIVITIES

MAKE SLIMY MIXTURES

MINI LAB Electronic

3008

Assemble the no-solder components and discover 6 activities to make your own alarm. Includes real components (light sensor, buzzer, transistors etc.) and instructions illustrated in colour for the activities.



BUILD YOUR ALARM

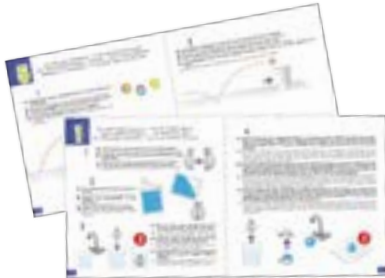

6
ACTIVITIES



MINI LAB Bouncy balls

3009

A kit for making colourful bouncy balls. Some even glow in the dark! Includes 5 sachets of elastic powder and instructions illustrated in colour with activities.

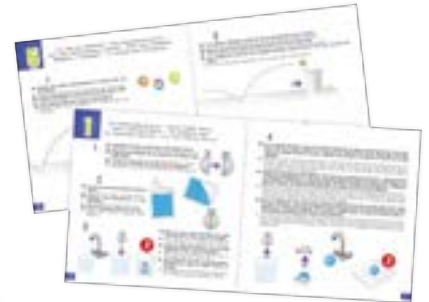

MAKE YOUR OWN
COLOURED BALLS!



6
ACTIVITIES

MINI LAB Bath balls

3010

A kit for making colourful bath balls. In the water, the balls make bubbles and colour your bath.

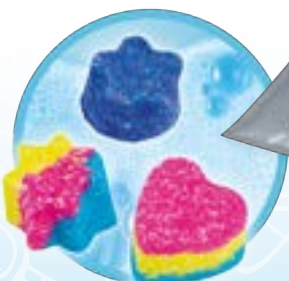

6
ACTIVITIES

MAKE FIZZY BOMBS FOR
YOUR BATH

MINI LAB Fluo & Glow

3011

With this set, you can conduct experiments that glow in the dark. Make your own lava lamp, invisible ink, phosphorescent slime, etc.
Includes many accessories, such as 3 colourings and a UV lamp.

8+

2 included

6

3 700802 102724



CREATE MIXTURES
THAT GLOW
IN THE DARK



6
ACTIVITIES

MINI LAB The chemistry of colour

3013

A kit for carrying out amazing colour activities: lava lamp, magic soup, density cocktail...
Contains: test tube, syringe, 3 colourings, coloured tablets and powdered red cabbage.

8+

6

3 700802 103097

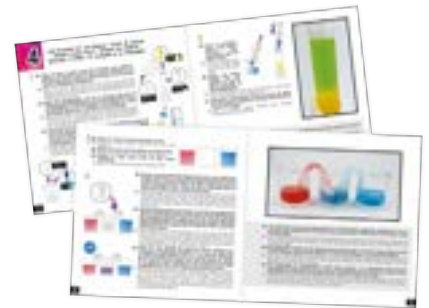
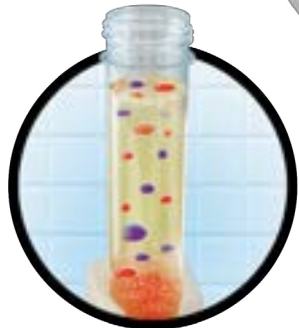

6
ACTIVITIES

DISCOVER THE AMAZING
SECRETS OF COLOUR

MINI LAB Space

3014

A kit for discovering space and observing the moon and stars: constellations map, solar system poster, lunar calendar...

Contains: a rocket ready for lift-off and powder to create a bouncy meteorite.

8+

6

3 700802 103103



6
ACTIVITIES

EXPLORE THE GALAXY

MINI LAB Magic science

3015

A set for performing magic tricks explained by science. Make objects levitate with static electricity, change liquid water into a solid and discover optical illusions. Contains: magic sand which dries in the wink of an eye.



MAGIC
EXPLAINED
SCIENTIFICALLY



10
TRICKS



MINI LAB Yucky science

3017

A kit containing six disgusting experiments: slimy worms, dripping eyes, bouncy poop...

Contains: beakers, pipette, measuring spoon, sodium alginate, colouring...



DISCOVER
DISGUSTING
EXPERIMENTS

6
ACTIVITIES



Chemistry - 75 experiments

8363EU

A chemistry set with 75 safe, chemical-free experiments! Perform fun scientific experiments with common household products like salt, vinegar and flour!

8+



3 700802 100355



Chemistry -150 experiments

8360

150 risk-free chemistry experiments! Experiment with mixtures using kitchen products such as eggs, vinegar, oil...

Includes a flask, test tubes and protective goggles.

Why does oil float on water? How does bicarbonate of soda react with vinegar? How do they make fizzy liquids?

8+



4 893338 083601



Chemistry lab 200 experiments

8364

Become a junior chemist with this multi-purpose laboratory: mixer, funnel, dripper, pourer, protective mat, and more.

200 experiments using safe ingredients found in any kitchen: density, mixtures, acidity, acid-alkali reactions, and more.



200
experiments



Wizard chemistry 30 experiments

8366

A cauldron to conduct 30 magical experiments and become a real wizard! Activate the light effects and smoke and use the magic wands to surprise your audience.

By pouring different ingredients, you will create amazing chemical reactions!

Each wand has a secret hatch to hide powder or liquid. 3 colourings and 5 chemicals are provided to help you complete the experiments successfully.



30
magical
experiments



Magic smoke



Light effects



Potion mixer



Micro chemistry 30 experiments

8367

30 experiments for an immersion in the microscopic world: instant crystals, polymerisation, acid-base reaction etc.

The kit contains three magnifying lenses to place on the workstation or the goggles for seeing in close-up. The workstation lights up from below. Many accessories included: pipettes, tweezers, measuring cup, Petri dishes, reagents...



30
EXPERIMENTS



3
MAGNIFICATIONS

ILLUMINATED
STATION



MOZEMHOUS
PLUS

Discover : Chemistry Challenge

SP005

30 scientific challenges inspired by videos from social media or brand new videos.

A tripod and a ring light allow you to film yourself easily with your phone. Measure your records with the chronometer and the measuring tape.

The use of a smartphone is not compulsory to conduct the challenges! Includes many scientific accessories: measuring cylinder, pipette, chemicals, slime powder, protective goggles...



More information page 41

Rocket science

2166

Build your rocket and carry out launches in total safety. Prepare your fuel with the ingredients supplied, fit the safety stopper and launch your rocket to heights of up to 15 metres!

You can then use ingredients of the house: baking soda and vinegar.

8+



3 700802 103424



Poster on the history of rockets



Illustrated instructions



3,2,1...
GO !!!



UP TO
15 M

Explosive science

2161

Discover 15 fun explosive experiments: a bomb, a geyser, a rocket... The kit contains foam protective pads and goggles for carrying out the experiments in total safety.

8+



3 700802 102847



Buki
France

Experimental Kits

Mega fluo & glow

2162

Discover 15 activities to try in the dark.

Light the UV lamp to admire fluorescent colours.

Make slime and phosphorescent bouncy balls that glow in the night.

8+

2 included

6

3 700802 102854



15 activities to try in the dark



UV Lamp

Mega sticky slime

2160

Discover 20 slimy activities involving different types of texture and hundreds of combinations: phosphorescent, gold, fluffy, ultra-slimy...

Includes: pre-dosed sachets to avoid mistakes in the recipe.

8+

6

3 700802 102212

20 sachets of slime



SLIMY WORMS

GLOWS IN THE DARK

ULTRA-STICKY!



Mega bouncy balls

2164

Discover 12 activities to create bouncy balls of all colours and shapes. Make a luminous ball and create an outside ball with elastic bands. Test your skill and dexterity.



Amazing crystal

2165

Cultivate 12 amazing and beautiful crystals: discover the instant crystal tree, make a crystallised jewel or grow a mega-crystal. Place your crystals on the luminous base and watch the light pass through them!

The activities use a microwave oven for greater speed and safety.



Dino Crystal

9009

Easily grow a large, colourful crystal dinosaur. Plunge the dinosaur into the crystallised solution and the crystals will grow after 48 to 72 hours. Includes: the dinosaur base, crystal powder, the growing beaker, globes and illustrated colour instructions.



Growth within 72 hours!



Buki France
Experimental Kits

Volcanoes and dinosaurs

2224

Discover 15 experiments you can do about volcanoes and dinosaurs: recreate volcanic eruptions at home, study volcanic rocks, make your own lava lamp, and dig up a Tyrannosaurus skeleton and then re-assemble it.

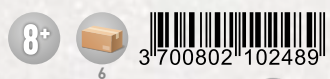

6 cards to discover volcanoes

Fingerprints

7101

12 experiments to discover the secrets of forensic science: find and compare fingerprints, analyse clues, construct a portrait of the suspect and write your own secret messages.



Buki
France
Experimental Kits

Sensory experiments

2169

A kit with 20 experiments to discover different textures: slime, fluffy, crystal, glitter, crunchy, galaxy... Customize your pastes, and use the included tools to shape them.

Included: a silicone mat to protect the table and play without messing.



NEW

Product in development
artworks, contents and
activities not final



SKELETON

SQUELETTE GÉANT

NEW

DISCOVER THE ANATOMY

Skeleton 45 cm

2180

Assemble the 45 cm skeleton to learn about anatomy. The bones have a realistic texture and colour. The skeleton is fully articulated and the child can place it in any position. A base is supplied to stand the skeleton on a desk. The child can stick labels on the bones to identify them. 10 X-rays are included!



REALISTIC
TEXTURE AND
COLOURS



45 cm

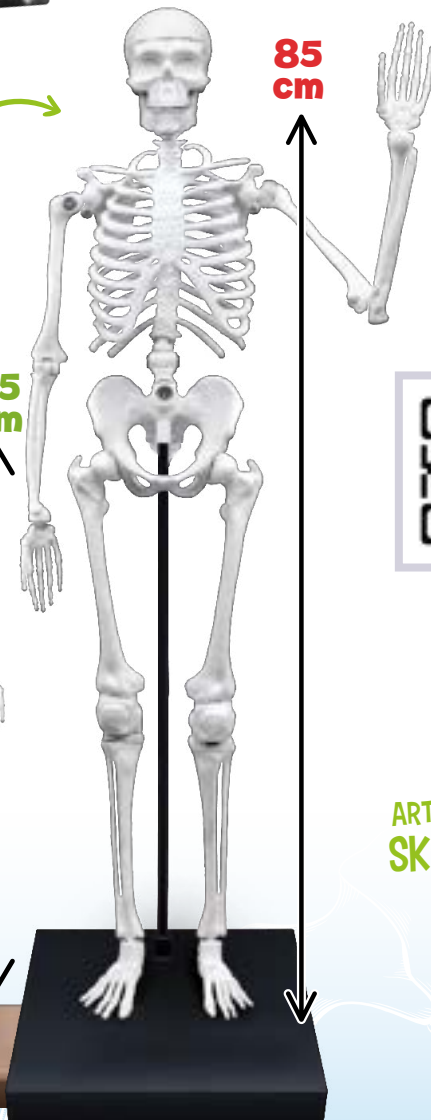

85 cm



Skeleton 85 cm

2181

Assemble the giant 85 cm skeleton to learn about anatomy. The bones have a realistic texture and colour. The skeleton is fully articulated and the child can place it in any position. A base is supplied to stand the skeleton on a desk. The child can stick labels on the bones to identify them. 10 X-rays are included!



ARTICULATED
SKELETON

Buki
France

Human body
& anatomy

Human body

2163

A model of the human body, with soft organs to dissect and phosphorescent bones.

Discover 12 experiments to understand the secrets of anatomy: cultivate bacteria, make slimy mucus and listen to your heart beating with the stethoscope.

8+



3 700802 103110

Soft organs and phosphorescent bones



Glow in the dark

A real stethoscope



12 EXPERIMENTS



Arcade cabinet

2167

Use the screwdriver included to assemble the controller, build the cabinet and connect the components: screen, loudspeaker and power supply. Customise your cabinet with stickers.

Discover 12 games inspired by the great arcade classics: puzzle, snake, breakout, shoot em up...

8+



Not included

3 700802 104292



Personalise your cabinet and play!

Assemble the gamepad and the cabinet!

Buki France
Corps humain & anatomie

Buki France
DIY

Pinball

2168

With the screwdriver included, assemble the elements to construct your pinball machine. Connect the components with the no-solder connectors: bumpers, LEDs and the score table. Personalise your pinball machine with the included stickers. The electronic board emits sounds whenever the ball hits the bumpers and keeps track of players' scores.



**EASY ASSEMBLY
AND NO-SOLDER!**



DIY Catapult

2171

Assemble the wooden parts to build your catapult. Easy to assemble without glue. Customize your catapult with the included stickers! Place the castle-shaped targets, and attack them. Three foam balls are provided. Range: up to 6 meters.

Booklet with medieval activities is included.



NEW



DIY

Electronic junior

7162

Assemble the components on the console and create 20 electronic assemblies: make the propeller take-off, learn Morse Code and use your voice to activate the circuit...

8+

2 AA
Not included

6

3 700802 104520



Electronic expert

7160

Assemble the components on the board and produce over 50 electronic circuits: alarm, sound effects, digital screen...

No-solder, i.e. no danger components are included: LEDs ; photosensitive, magnetic and touch sensitive switches ; transistors, resistors, loudspeaker, rotating light...

8+

2 AA
Not included

6

3 700802 101833



MAKE ANIMAL SOUNDS



MAKE THE LEDS FLASH

TOUCH-SENSITIVE SWITCH



Electricity

Electricity lab

2172

An electricity set with 22 activities to make easy circuits without soldering and discover electricity.

How does a motor work? What is the difference between a series circuit and a parallel circuit?

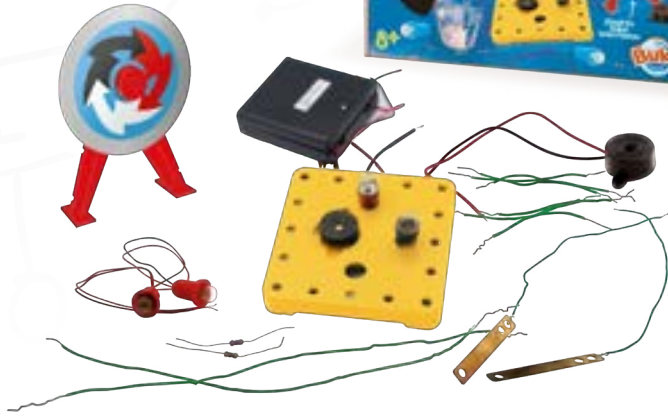

Product in development
artworks, contents and activities not final

Electricity expert

7153

Create circuits and build 17 models: lighthouses, Ferris wheel, helicopter, and more.

A kit to understand and discover the basics about electricity.

More than 130 pieces required for circuits: rod, motor, battery box, connection wires, etc.



Please contact us for the availability of this item



Electricity

Gyroscope Robot

7509

Assemble the parts to build 6 different robots: spinning top, buggy, motorbike, roller coaster...

Works with a gyroscope: once activated, it balances the models and makes them move.



Please contact us for the availability of this item

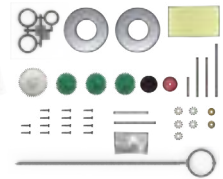

Wind turbine

7400

A giant 90 cm wind turbine to assemble and set up in the garden. The wind turns the blades and the generator produces electricity to charge a battery (not included).

The electricity generated can power a self-assembly vehicle.



Please contact us for the availability of this item

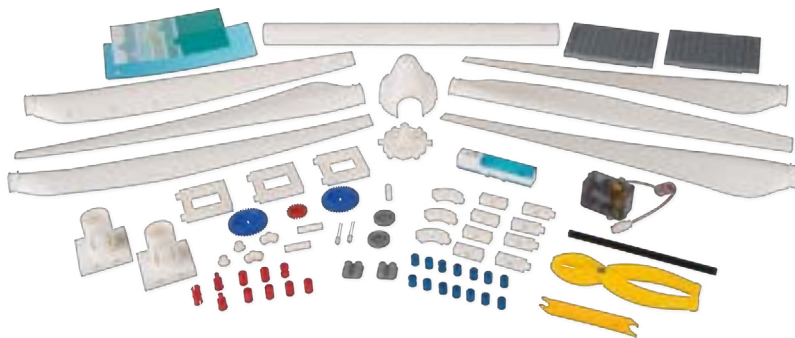

Buki France
Robots
construction

ASSEMBLE THE WIND TURBINE

IT PRODUCES ELECTRICITY THAT POWERS THE MODELS.

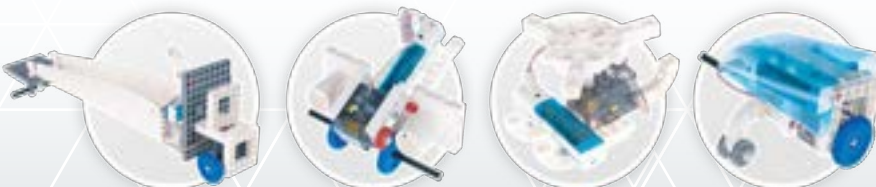

Air power car

7502

Put the parts together and build a vehicle powered by compressed air. Simply use the pump to fill the compressed air gauge. When the indicator is at green, the vehicle is ready to set off!

8+



3 700802 101130

Please contact us for the availability of this item

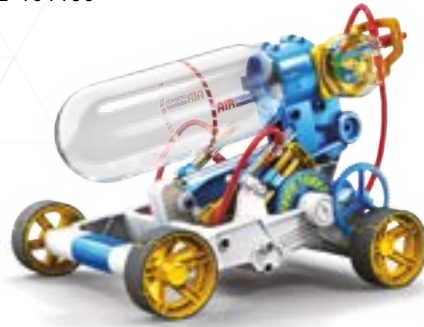

Solar energy 14-in-1

7503

Assemble the parts and build a robot powered by solar energy. 14 models can be built, including a car, a crab, a boxer and a boat. The panel captures the sun's rays or a lamp of at least 50 W and transforms them into electricity.

8+



3 700802 101529



Please contact us for the availability of this item



Robots
construction

Hydraulic robot arm

7505

Build an articulated robot arm by assembling the parts. Pour water into the hydraulic system and control its movements in all directions with the 6 levers. It can carry objects weighing up to 50 g with its gripper or suction cup. No batteries required.



Please contact us for the availability of this item



180°

SUCTION CUP
+
GRIPPER



EASY
ASSEMBLY

Hydraulic cyborg hand

7508

Build an articulated cyborg hand by assembling the parts. Add water to the system and control it with your fingertips. The hand can be adjusted to carry objects such as balls or bottles. It can be adapted for both left-handed and right-handed use.



Please contact us for the availability of this item

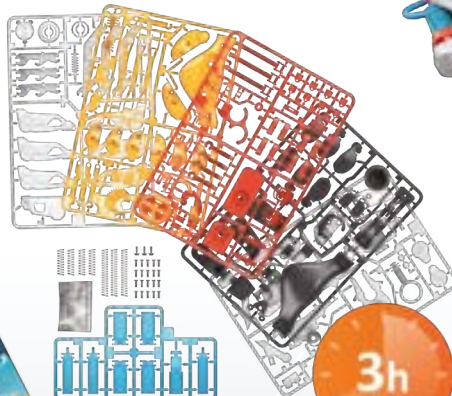

Blaster Hand

7080

Assemble the parts and build a blaster hand working thanks to pneumatic energy. Put your hand inside the blaster and pump to fire the darts. The blaster works equally well for left-handed people and for right-handed people.

The barrels can be moved to attack from multiple angles. Two firing modes: precision and burst mode. Six darts are included. The blaster is compatible with most other foam darts.



Please contact us for the availability of this item



EASY ASSEMBLY

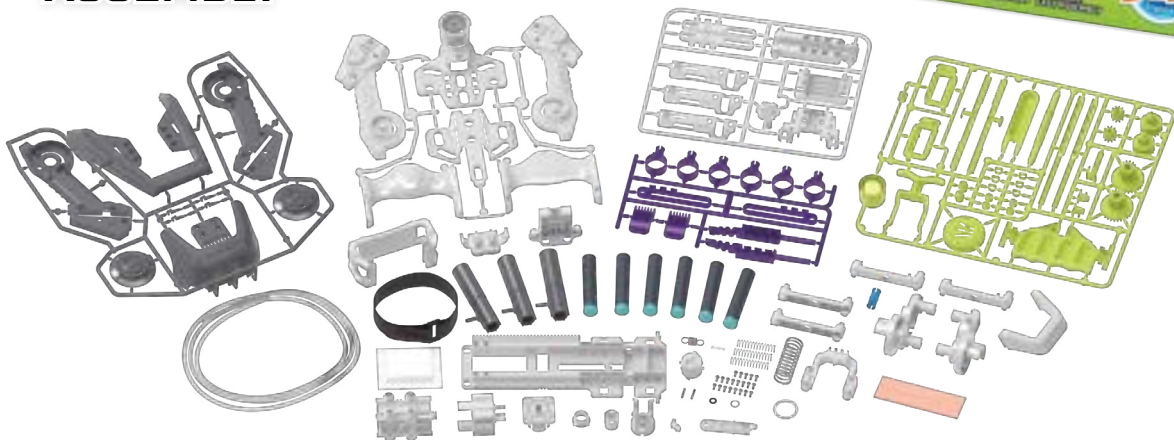

Robots
construction

NEW

Please contact us for the availability of this item



Hydraulic Boxers

7510

Two boxers to assemble, powered by hydropneumatic energy. Use the controllers to trigger the boxers' moves: hook, uppercut, counterpunch and dodge. A well-placed blow can knock the opponent's head off. 327 parts to be assembled.

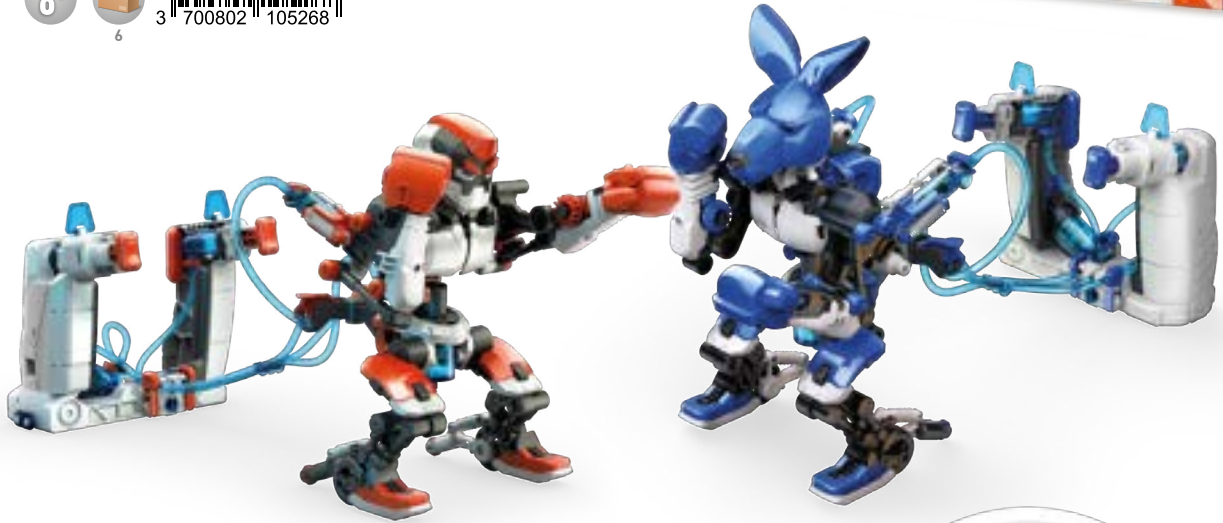

Buki
France
Robots
construction

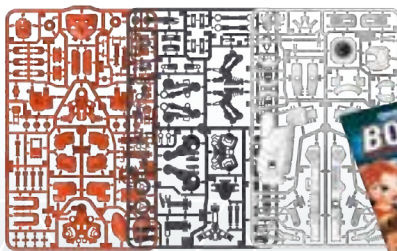
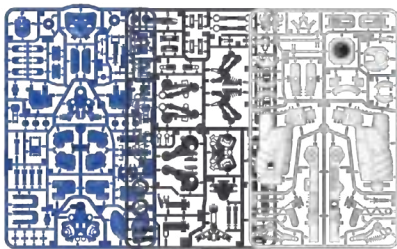

EASY ASSEMBLY





DRAWING



GRIPPER



FORKLIFT



BASKETBALL



FOOTBALL

Kodo

7507

Assemble Kodo the coding robot and discover its 5 functions: drawing, forklift, pincer, basketball and football player. The coding wheel allows the robot to be programmed and given tasks without using a computer or tablet.

8+ 2 AAA Not included 6 3 700802 102892

Please contact us for the availability of this item

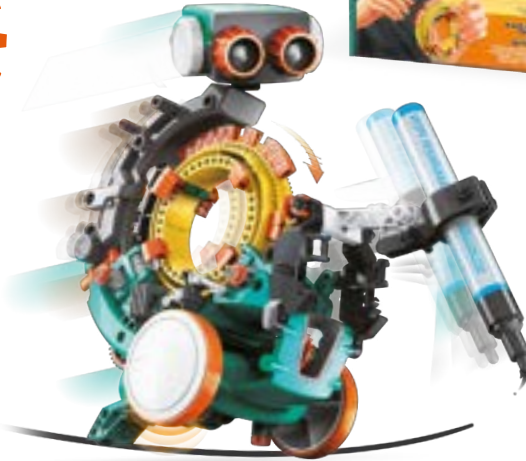

PLACE THE CONNECTORS ON THE DISC TO PROGRAM YOUR ROBOT.

Tibo the robot

7506

Assemble Tibo the robot and discover its amazing functions:
- Follow mode: using its sensors, the robot detects the child and follows their movements.
- Explorer mode: the robot wanders around the room and avoids obstacles, using its six limbs for 360° movement.

Please contact us for the availability of this item

8+ 4 AAA Not included 6 3 700802 102243



360° MOVEMENTS

2 MODES



FOLLOW ME



EXPLORER

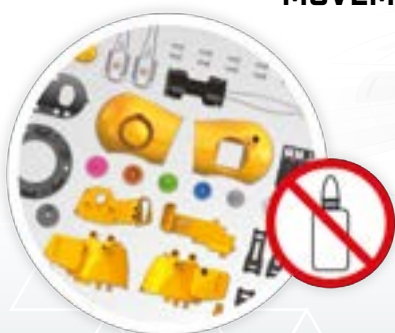

EASY ASSEMBLY



Robots construction

Robot Marko

7601

Discover Marko and his 20 amazing functions: walking, sound and music, dancing...

Program the robot using the infrared remote and discover 10 games to explore the world of coding. You can also control him with your hands!



3 700802 103028



PROGRAMME DIRECTLY WITH THE REMOTE CONTROL



20 DIFFERENT FUNCTIONS



10 CODING GAMES



HAND CONTROLS



MEMORY HOLDS UP TO 50 ACTIONS



ILLUSTRATED INSTRUCTIONS



10 DIFFERENT SOUNDS AND MUSIC



RECHARGEABLE BATTERY (USB)



Robots
construction

4x4 R/C

8019

Assemble your all-terrain vehicle by following the step-by-step instructions. Two models: pick-up and 4X4. Once assembled, drive the car with the remote control and take part in four driving challenges. The car moves in every direction: forwards/backwards/right and left. Frequency 2.4 GHz

Not included
 Not included
 6
 3 700802 104995



Sports cars R/C

8025

Build your sports car by following the step-by-step instructions. Two models: supercar and cabriolet. Once assembled, drive the car with the remote control and take part in four driving challenges. The car moves in every direction: forwards/backwards/right and left. Frequency 2.4 GHz

Not included
 Not included
 6
 3 700802 105008



Robots
construction

Pocket microscope

MR200

A pocket microscope for exploring the microscopic world with magnification of up to 120X.

Includes a quiz sheet about everyday objects that are easy to observe. Compatible with most smartphones.



Use the pliers to take pictures with your phone!



A microscope you can carry anywhere!

Microscope 15 experiments

MR400

Observe the microscopic world with a microscope featuring 400x magnification, ideal for beginners.

15 experiments to understand the materials around us, with equipment for preparing your own samples.



15 experiments



Microscope 30 experiments

MS907B

One 23-cm microscope with lenses, colour filters and 3 magnifications: x100 / x600 / x1200.

The base and body of the microscope are made of metal. LED light for high-quality observations.

A large number of accessories included: slides, tweezers, vials, Petri dish, micro-slicer, labels, needle and sample slides. Instructions with 30 experiments for learning to prepare slides, collect samples, adjust the microscope and the light.



Zoom

100X

600X

1200X



30
experiments



Binocular microscope 3D

MR500

A stereo microscope with eyepieces and glass optics for observations of objects in volume.

Place the sample in the middle of the stage, switch on the LED light, focus to sharpen the image and observe the object in all its forms.

Instruction sheet in colour with 40 experiments included.



LED lighting



3
insect
samples
included

3
rock
samples



Two glass
eyepieces



+ 1 instruction sheet
in colour with

40
experiments

Microscope - 50 experiments

MR600

A metal microscope with glass lenses and eyepieces for high-quality observations!
3 zoom levels: X 100 - X 250 - X 1000 HD
Includes many accessories: slides, tweezers, vials, mixer, labels, Petri dish, micro-slicer, and more.



8+ 1 eyepiece included 3 AA Not included 4 3700802101208

Glass eyepieces

Zoom

100X

250X

1000X HD



50 experiments



3-in-1 Microscope

MR700

A 3-in-1 microscope for exploring the microscopic world.

USB webcam mode: for carrying out observations using a Mac or PC.

Smartphone mode: use a mobile phone or tablet for your observations.

Optical mode: use it like a conventional microscope.

Up to 400x zoom. Dual LED lighting. Various accessories included: scalpel, tweezers, 15 samples.



Dual lighting

15 samples

Zoom

100X

200X

400X

+ 1 instruction sheet in colour with

40

experiments



USB camera



Phone support



Removable head

Microscope slides

MR001

A set of microscope slides with 20 prepared specimens including rabbit blood, sunflower pollen, bamboo, cricket wing, etc.

Compatible with all Buki microscopes, except the MR500 - 3D Binocular.



14 slides
20 Samples



+ illustrated booklet



Day and Night Globe

7345

A 21cm globe to observe the earth during the day, and the constellations at night.

Daytime: explore the globe with its political borders, seas, mountains, and cities.

By night: gaze at 88 constellations and learn their names! The LED provides soft lighting, so that kids can use the globe as a night light.

Assembled globe measures 21cm across on metal stand. Comes with USB cable and mains adaptor.



Buki
France

Space

Instruction sheet
with colour
illustrations
to learn about
geography.



Constellations



Brass
base



If other mains adapter is
required, please contact
our team.

This globe is available in several languages: French, Dutch, Spanish and Italian.



7345NL



7341ES



7341IT

Globe City Lights

7347

A 2-in-1 luminous rotating globe. Pick up the globe: it carries on rotating in your hands. Place it on its base to reproduce the actual inclination of the Earth.

During the day, discover the continents and the landforms with a satellite view of the Earth. In the dark, the globe lights up and the largest cities of the world are illuminated as though seen from space.

Diameter: 20 cm.



Rotating



In the dark :

the globe lights up and the
largest cities of the world
are illuminated

Daytime :

Discover the
continents and reliefs

Magnetic world map

7346EN

A 70 cm by 38 cm world map for exploring the countries of the world. The map can be hung on the wall or placed on a desk thanks to its easel system. 40 magnetic pieces representing major geographic zones can be positioned on the map. There are also 50 magnetic flags and pins you can use to mark the countries you have visited or would like to visit. With the photos and the illustrated roadbook, you can explore the most beautiful monuments, roads and landscapes around the world.

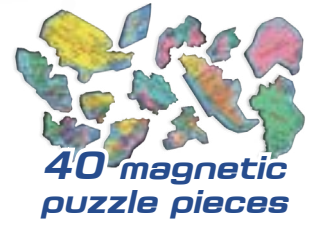

This map is available in several languages: French, English, German, Dutch, Spanish and Italian.



7346



7346DE



7346NL



7346ES



7346IT

Motorized solar system - 2-in-1

7255

Discover the solar system and its 8 planets, which rotate according to real orbit cycles over a period of 35 minutes. The Sun in the centre lights up like a night light. Convert the model to show the Earth and the Moon, and reproduce eclipses with the lamp included.



SOLAR SYSTEM MODE



EARTH AND MOON MODE



The 8 planets rotate according to real orbit cycles

The Sun lights up like a night light



5 activities

Earth

3DF2



0 605566 121031

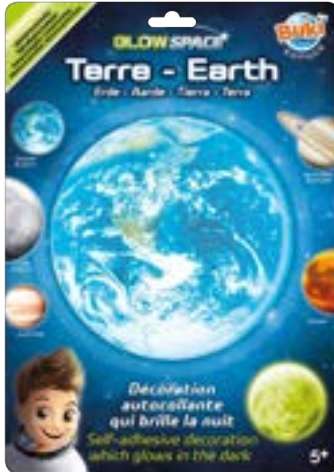

Moon

3DF3



0 605566 121048

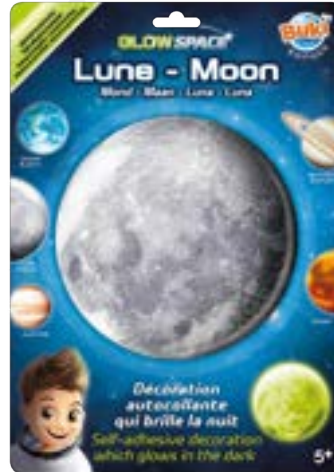

Saturn

3DF4



0 605566 121055

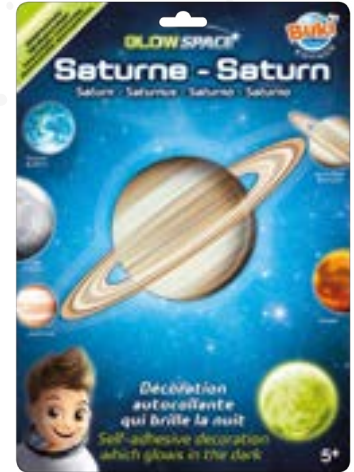

Buki
France

Space

Jupiter

3DF6



0 605566 121062



Mars

3DF8



0 605566 121079



Phosphorescent Planets

Phosphorescent planets to be stuck onto the bedroom wall or ceiling. One minute of exposure to light, and they will shine for one hour! Wall adhesive included.



3D stars

SB50

50 phosphorescent stars to stick on bedroom walls or ceilings. Expose the stars to the light for one minute and they will shine for one hour!



0 605566 121017



Solar System

3DF10

Stuck this glow-in-the-dark solar system onto your bedroom wall or ceiling, and discover the universe. Wall adhesive included.



3 700802 102151

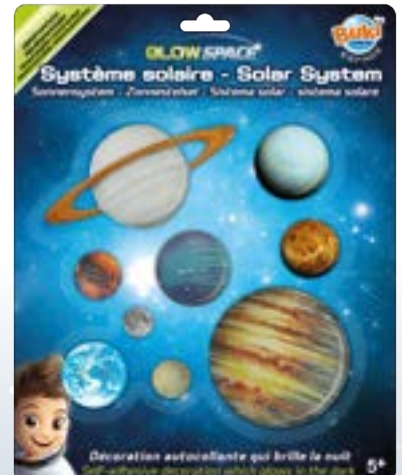

Planetarium HD

8002

A planetarium for discovering space. Its ultra-bright LED light and lens project high-definition images. The planetarium rotates.

Three discs included: the Milky Way, the constellations and the solar system.

Included: a leaflet with activities to discover the sky.



Space

Ultra-bright LED lighting



Motor-driven rotation



3 discs



Solar system



Milky way



Constellations

Refill planetarium discs

8003

Three additional discs for the HD Planetarium from Buki France (8002): lunar landscapes, Europe from space and the robots of Mars.



Lunar landscapes

Mars and its robots



Europe from space

Moonscope - 30 activities

TS009B

This telescope has been specially designed to observe the Moon and features a large diameter, a K 10 mm eyepiece and a lunar filter.

It also has a smartphone adapter making it easier for children to take photographs. Includes a 110 cm tripod (ground-mounted).



Adjustable tripod
110 cm



Glass optical elements



+30 activities



Phone adapter

Telescope - 15 activities

TS006B

A starter telescope with a 15-activity instruction booklet. Discover the starry sky, the planets and the Moon's craters. The telescope can also be used for observations during the day: animals, monuments etc.

Lens 50 mm in diameter and two interchangeable eyepieces (20 and 4 mm). Floor tripod measuring 89 cm.

A sky map is included.



+15 activities

Easy to set up



Tripod
89 cm



Telescope - 30 activities

TS007B

A telescope that comes with an instruction sheet with 30 activities to discover the starry sky, the planets and the lunar landscape! Includes: 50 mm diameter lens and 2 interchangeable 20 mm and 4 mm eyepieces. 89 cm tripod. Several accessories included: 6x25 mm finderscope, 1 2.3x Barlow lens, 1 sky map to find your way. The tube and the tripod are made of metal.



Find the details of our range:



Glass optical elements

30 activities

Telescope - 50 activities

TS008B

A reflecting telescope with a 50-activity instruction booklet for exploring the starry sky, the planets and the Moon's craters.

Lens 76 mm in diameter and 3 interchangeable eyepieces (20, 12.5 and 4 mm). Floor tripod measuring 76 cm. The tube and tripod are metal.

Many accessories included: 6x25 mm finder lens, a 3x Barlow lens, a sky map for identifying stars.



Glass optical elements



50 activities

360° rotation

Great stability



Plasma ball

SP007

A plasma ball 13 cm in diameter, ideal for decorating a bedroom. It reacts to touch and creates totally safe lightning bolts of electricity. Also reacts to sounds! Includes: 5 amazing experiments on static electricity. Works with a mains EU plug, included.



If other mains adapter is required, please contact our team.



Volcano lamp

SP002

Fill the lamp with water and add the marbles. Switch on the lava lamp: it produces a relaxing volcanic eruption! Includes: 5 amazing experiments on volcanoes. Works with a mains EU plug, included.



If other mains adapter is required, please contact our team.

Tornado lamp

SP004

A 24 cm tornado lamp, ideal for decorating the bedroom. Pour in the water and add the glitter. The lamp has a LED, which changes colour and reproduces a submarine tornado. Included: discover 5 surprising experiments on water.

Works with a mains EU plug, included.

14+



6



3 700802 104223

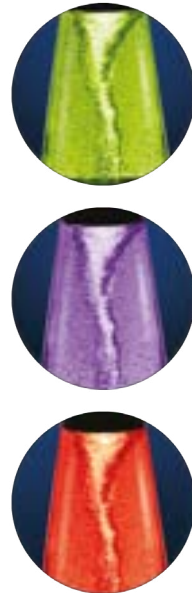

If other mains adapter is required, please contact our team.

Flying ball

SP006

An illuminated flying ball for playing alone or with friends. Guide your ball so that it flies through the air. Can be used indoors or outdoors. Rechargeable with the USB cable included.

8+



included



6



3 700802 105053



Luminous



The ball spins and fly!



Rechargeable

Diameter:
∅ 8 cm

Buki
France

Science PLUS

Chemistry Challenge

SP005

30 scientific challenges inspired by videos from social media or brand new videos. A tripod and a ring light allow you to film yourself easily with your phone. The use of a smartphone is not compulsory to conduct the challenges!

Use the chronometer and measuring tape to assess your performance.

Includes many scientific accessories: measuring cylinder, pipette, chemicals, slime powder, protective goggles...



30
scientific challenges



#WORLDRECORD



Illustrated colour instructions and challenge cards



#PRANK

Tripod and light ring
to film yourself with a mobile phone
(not included).



Film and share your successes with others.



#SATISFYING

Buki
France

Science PLUS

Expert Binoculars 10 x 25 mm

SP008

A pair of 10 x 25 mm binoculars for seeing 10 times larger! Focusing ring for clearer images and non-slip coating for a solid grip. Tinted lenses for more natural colours. The binoculars are compact and lightweight. Carrying pouch and cleaning cloth included.



Compact and light!

Carrying pouch



Expert Monocular 12 x 20 mm

SP009

A compact monocular for observing nature and monuments. 12x magnification, diameter 40 mm. Take photos easily with the smartphone adaptor and tripod. Easy to transport with the carrying pouch and cleaning cloth included.



Easy to carry!

Phone adapter

Tripod





Adventure climbing

BN016

An introductory kit for climbing in total safety.

6 straps and 12 holds to install quickly and easily around a tree to create adventure routes. The straps are attached with secure ratchets.

Up to 100 kg. Carrying bag included.



3 700802 104162



Buki
France

Nature

Handbow

BN015

A handbow for practising shooting in total safety. The mechanism and the sucker bolts ensure risk-free use.

Includes: 6 bolts and a portable target.



3 700802 104094



Metal bow

Safety trigger

Safe suction bolts



Slingshot

BN017

A slingshot to help you survive in the forest. Lightweight portable design. The child shoots a foam bottle that "explodes" when hit. Includes: 3 safe darts and spare elastic bands. Range: 20 m.



Blowpipe

BN020

A safe blowpipe with safe suction cup darts included. The blowpipe is lightweight and easy to carry everywhere!

Includes: 3 safety darts and 3 cardboard targets.



Terrarium

BL034

A terrarium for recreating the habitats of small animals: insects, snails, spiders, tadpoles, beetles, firebugs... Collect plants and stones with the tweezers to decorate your habitat.

Watch the animals with the removable x6 magnifying glass and the graduated x3 magnifying glass. Illustrated booklet with 6 example habitats to build.



Nature

Bug viewer

BL010

Tweezers to catch an insect and place it in the bug-viewer.

Thanks to the two zooms (x6 and x4), you can study the insects in detail.

Comprises handles for better stability. Possibility of examining the insects with a friend.

5+



3700802 100584



Bug vacuum

BL052

A vacuum to catch and observe insects without harming them!

3 speeds, 1 container and 2 nose cones.

6+



3700802 100591



Insect explorer kit

BL033

Catch, observe and learn about 5 different insects: flies, butterflies, ants, grasshoppers and ladybirds – through amusing anecdotes and experiments.

6+



4893338 120337



Buki
France

Nature

Marine monsters

125

Marine watches with a one-year lifespan to be "tamed" in a phosphorescent aquarium!

Simple to use in 3 steps:

1. Add bottled water
2. Hatch your eggs
3. Feed them!

Once the artemias have hatched, you can watch them twirl, swim and even reproduce with the built-in magnifying glass!

3 sachets provided: purifier, dehydrated eggs and food for 1 year.



3 700802 101574



Built-in magnifying glass



Glow in the dark



Feed them

Breed artemias



Litter picker

BN013

With the litter picker, you can take part in the big clean-up to preserve natural spaces. With its rotating head, the litter picker can lift objects weighing up to 5 kg. Work gloves included.



3 700802 103134



5 activities

Sound amplifier

KT801

A sound amplifier for listening to the sounds of nature when walking in the forest, or for spying on your friends! The sound amplifier has a listening range of 30 metres! Headphones are included.



3 700802 103240

RANGE
30 m



Nature Trek

BN014

A set for setting off on adventures in the forests and mountains. Watch animals with the 5x32 mm binoculars, find your direction with the compass, light your path with the headlamp and count your steps with the pedometer. Included: light practical storage bag.



Binoculars
5x32mm



Bluetooth Lantern

BN018

A rechargeable camping lantern with Bluetooth speaker function. Charges via the built-in solar panel or a USB cable. 3 lighting modes. The lantern is also an external battery pack and can recharge other electronic devices. Connect a phone or tablet via Bluetooth to play music through the speaker. Red light mode for telling scary stories. Four cards with portraits of frightening figures included. Works with a lithium battery and USB cable, both included.

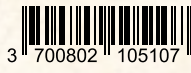

Nature



+ 4
Scary stories



Stream your music



Rechargeable



3 light modes

Head torch

BN019

The head torch is an ideal companion for night-time exploration in the woods. Its 1W 100 lumen LEDs provide powerful and efficient lighting. The elastic strap adjusts to fit all sizes.



Maxi binoculars - 8 x 50 mm

BN010

A pair of 8x50mm binoculars to help you see 8 times further! Focus rotation wheel for more clarity. Anti-slip coating for better grip. Tinted lenses for more natural colours.

8+



3 700802 100096



Binoculars - 4 x 30 mm

BN009

A pair of 4x30mm adjustable binoculars to help you see 4 times further and observe nature! A colourful design, small size and rubber coating for a better grip for children. Cord to put the binoculars around the neck. Included : small bag and lens cleaning wipe.

6+



0 729983 080099



Binoculars

9001

Binoculars designed especially for little ones to see 3 times further and observe the world around us.

Light and robust, these binoculars don't need to be focused and are easy to use.

4+



3 700802 101734



Expert Monocular 12 x 20 mm

SP009

9+



3 700802 105220



Expert Binoculars 10 x 25 mm

SP008

9+



3 700802 105213



To discover page 42

Buki
France

Nature

Walkie-Talkie

TW01

Explore the world using walkie-talkies with a range of 3 km.

Many functions: 8 channels for use anywhere, call mode with 10 call tones, built-in torch, backlit screen...

8+

8 AAA
Not included

6

3 700802 101666



RANGE
3 km

Walkie-Talkie - rechargeable

TW02

Explore the world using rechargeable walkie-talkies with a range of 4 km. Works with lithium batteries and an EU mains adaptor, both included.

Many functions: 8 channels for use anywhere, call mode with 10 call tones, backlit screen...

8+

1 Rechargeable
included

6

3 700802 102199



RANGE
4 km



**DOUBLE BIT
ADAPTER INCLUDED
(EU-standard)**

If other mains adapter is required, please contact our team.

Walkie-talkie junior

TW03

Walkie-talkies specially designed for toddlers: easy to use with its LED indicators and its size adapted to small hands.

Range up to 2 km, call mode and ergonomic design. Ideal for spy games, camping, parks, the beach.

4+

6 AAA
Not included

6

3 700802 102205



Buki
France

Nature

Walkie-Talkie messenger

TW04

A pair of dual-function walkie-talkies for voice calls and writing messages. Children can make calls and talk to each other on 8 channels within a range of 3 km. They can send messages and emojis within a range of 1 km using the complete keypad. The devices can store 50 messages. Works with rechargeable batteries and an EU mains adaptor, both included.



VOICE RANGE
3 km

SMS RANGE
1 km



RECHARGEABLE

If other mains adaptor is required, please contact our team.



Backlit Screen



Complete keypad



10 Emojis

Metal detector

KT7020D

A metal detector that helps you to find real treasure! The detector has a backlit digital display as well as an audio feature with controllable volume. The detection sensitivity can be adjusted.



Metal detector expert

KTD2000

A metal detector for discovering metal objects. The LCD screen tells you about the type of metal found!

Detects: iron, steel, copper, aluminium, silver and gold...

The handle length is adjustable for easier searching. Possibility to adjust the sensitivity and the volume.

Includes: instructions with 15 activities for beginners and advanced users.



LCD screen



Water-resistant head

Adjustable handle

Illustrated booklet with 15 activities



Tarentula R/C

37291

A radio-controlled tarantula with booklet, for fun while learning! The controller has a range of 7,5 m and can move the spider in 4 directions: forward, backwards, left and right. The spiders legs have joints.



3700802 100942

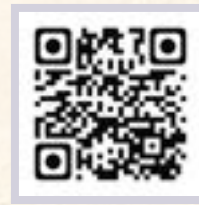

Poster to discover spiders



7.5 m



Shark R/C

37292

A 34 cm radio-controlled shark to frighten your friends! The shark moves in all directions and swims realistically. 3 swimming speeds are available. The remote control has a range of 20 metres and can be used in water. Ideal for the swimming pool or bath.



3700802 104179



3 SPEEDS



34 CM



ATTACK MODE



WATER RESISTANT



REALISTIC MOVEMENTS



Plane R/C

37294

An easy-to-fly radio-controlled plane for indoor and outdoor use. The integrated gyroscope keeps it stable. The body is made of anti-impact foam. The plane works with a 3.7 V lithium battery and is recharged with the USB cable supplied. The radio control has a range of 40 metres.



Flying science

2173

Discover 6 flying toys to test outdoors or indoors: 4 rockets, 2 planes, 1 glider, 1 helicopter launcher, 1 parachute and 2 mini-rockets.

Using the foot pump, rockets and planes take off from heights of over 25 meters!

Booklet included with scientific activities on flying.



Nature

DINO Surprise Box

2135

A box containing 25 surprises on the theme of dinosaurs. Choose a bag, open it and discover your surprise: badges, a jigsaw puzzle, skeletons to assemble, figurines and dinosaur teeth to make into a necklace.



The bags are numbered 1 to 25, and the kit can also be used as an advent calendar! Plastic-free paper packaging.



25
Surprises !

Dinos 3D - Display 24 pcs/ 6 models

D6B

A display with 24 wooden dinosaurs to assemble without glue!

6 models available: Triceratops, Tyrannosaurus, Brachiosaurus, Parasaurolophus, Stegosaurus and Pteranodon.



Dinos & archaeology

Dino Magic Eggs - Display 12 pcs

D6G

Submerge the egg in water to hatch and grow a dinosaur.

6 models to collect: Triceratops, Tyrannosaurus, Brachiosaurus, Spinosaurus, Stegosaurus and Ankylosaurus.



144/12



Dino egg - Display 12 pcs

D60

Eggs that you can dig to discover small dinosaurs, collect them all!
12 assorted styles. One tool to dig included.

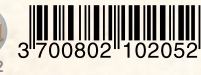

72/12



Dino builders

2136

Assemble the three dinosaurs with the screwdriver. They are fully articulated.

Three models included: tyrannosaurus, triceratops and pteranodon.



6

ARTICULATED LIMBS

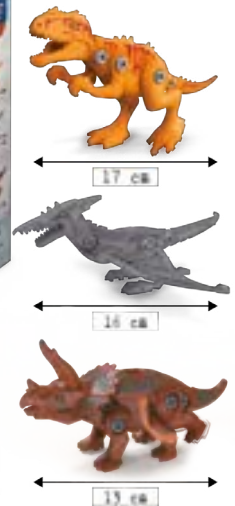

EASY ASSEMBLY
with the screwdriver



Buki
France

Dinos &
archaeology

Dino mega egg

2137

Dig four 3D dinosaur puzzles from the giant 18 cm plaster egg: Tyrannosaurus, Diplodocus, Stegosaurus and Styracosaurus.

Includes: digging tools and a tray for mess-free digging.

8+



3 700802 104100



18 cm
Giant
Egg!



4
3D dinosaurs
puzzles



Dino egg maxi pack

2138

A set with 12 eggs to dig out to unearth 12 different dinosaurs, including Tyrannosaurus rex, Brachiosaurus, Triceratops, Pteranodon and Spinosaurus. Decorate your bedroom with the poster. Includes: excavation tools and a tray for excavating without making a mess.

6+



3 700802 104629



12 dinosaurs
to unearth



+ 1 Poster
to discover dinosaurs



Buki
France

Dinos &
archaeology

Museum dino skull

2130 - 2131

Dig up a dinosaur skull with the tools supplied: hammer, chisel and brush. Includes: a tray for mess-free digging. The dinosaur skull can be exhibited on a plinth, like in a museum.

Two models: Tyrannosaurus and Triceratops.



Tyrannosaurus

2130



3 700802 104872

Triceratops

2131



3 700802 104889



Buki
France

Dinos &
archaeology



Dino kit - assortment

439

Using the hammer and chisel, dig the dinosaur skeleton out of the fossil block, and then assemble it!

Includes: a plaster refill packet to bury the skeleton and start the dig again!

4 assorted models: T-Rex, Stegosaurus, Brachiosaurus and Triceratops.



0 605566 121352

Triceratops

439TRI



3 700802 100508

Brachiosaurus

439BRA



3 700802 100515

Stegosaurus

439STE



3 700802 100522

T-Rex

439TYR



3 700802 100492



Dino dig - 2 models

2139

A block of plaster to dig up the bones of a Tyrannosaurus Rex and a Velociraptor! You must then work out which dinosaur the bones belong to and build the two skeletons! Possibility of digging in the box to avoid any dirt.

8+



+ 1 Poster
to discover dinosaurs

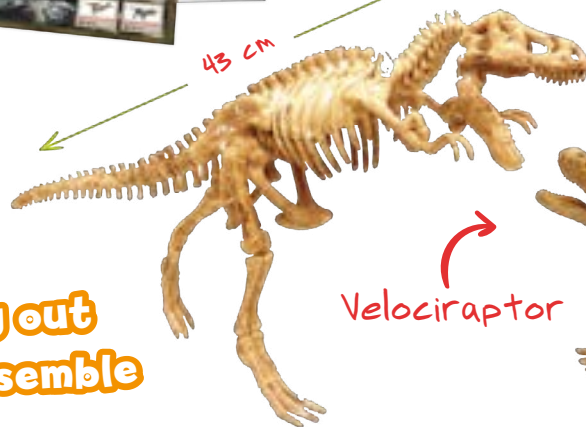

T-rex

Velociraptor

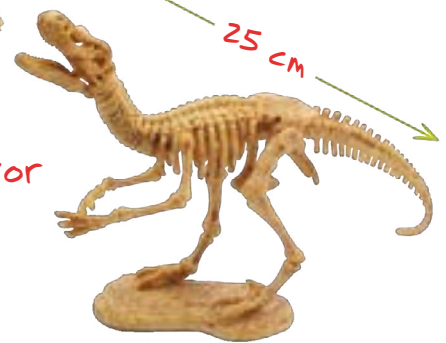

**Dig out
& Assemble**

Mini volcano

2225

Reproduce a volcanic eruption using the tablets included. Use the tools to dig in the volcano and unearth 5 volcanic rocks.

8+



1 Eruption



2

**Dig
&
observe**

Buki
France

Dinos &
archaeology

Dig kit – Rocks and minerals

440

Use the tools to dig up and observe seven real stones, including white quartz, obsidian, turquoise and agate. Includes a tray for mess-free digging.

8+



Dig kit – Shells

441

Use the tools to dig up real shells of different shapes and create your own bracelets with the thread provided. Includes a tray for mess-free digging.

8+



Space rocks

442

Use the tools to dig up and observe five stones from space, including a real stony meteorite and tektites.

Includes: a tray for mess-free digging.

8+



Gold prospector

443

Two gold prospecting techniques to discover: panning to separate gold from sand and mining to dig up nuggets of fool's gold.

Many tools included: pan, hammer, chisel, pipette, tweezers...

8+



3 700802 104865



Collect



Dig

The pyramid mystery

444

Decipher the hieroglyphics carved on the four faces and find the secret mechanism to open the pyramid. Then dig up the five Ancient Egyptian treasures with the tools included. Display your pyramid and the treasures in your room.

8+



3 700802 105466



Dig up the treasure



Solve the mystery



Buki France
Dinos & archaeology



Binoculars

9001

Binoculars designed especially for little ones to see 3 times further and observe the world around us.

Light and robust, these binoculars don't need to be focused and are easy to use.



48/6

3 700802 101734



Bug Viewer

9005

Open the observatory, place an insect inside and examine it through the magnifying glass, which enlarges 6 times! Release the insect quickly to avoid hurting it.



72/12

3 700802 102083



Magnifying glass

9007

An easy-to-handle magnifying glass for younger children which magnifies 2, 3 or even 4 times! The magnification varies depending on the area of the magnifying glass.

Magnifying glass diameter: 10 cm.



6

3 700802 102113

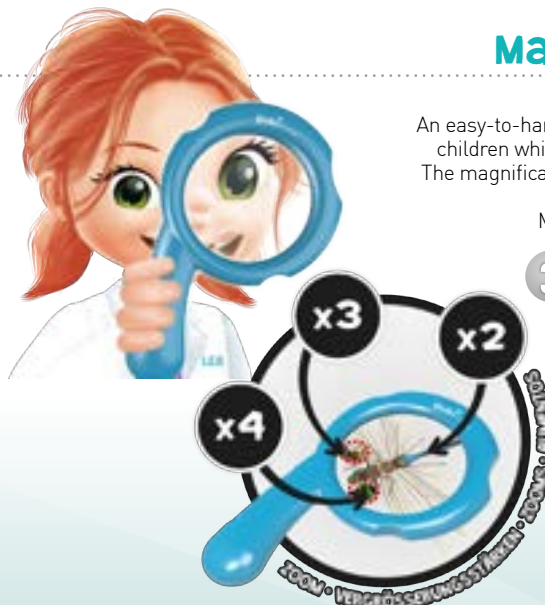

Lantern 3-in-1

9006

A 3-in-1 lantern for discovering animals.

3 modes: projector, night light and torch. LED lighting with a 15-minute timer. Includes three discs of eight slides.

3+

3
LEDs
Included

48/6

3 700802 102090



Torch

6340

A torch with a LED lighting! Power secured to protect children's eyes.

Lace included to wear the torch on your wrist. Easy handling for toddlers. Torch height: 13 cm.

4+

2
AAA
Not included

12

3 700802 105565



Product in development
artworks, contents and activities not final

Telescope

9004

A binocular telescope to observe the world around you. Use the tripod to stabilize the image and the wheel to make a perfect focus. Ideal for both day and night observations.

Contains child-friendly accessories: a x15 telescope, diameter 35 mm, a 30 cm tripod.

4+

6

3 700802 101765

Find the details
of our range:



Buki
France

Mini Sciences

Chemistry

9002

Discover chemistry and mixtures with child-friendly accessories and 10 experiments explained step by step. Contains: weighing scales, test tubes, beakers and a pipette.

4+

3

3 700802 101741



Contains:
10 illustrated experiment sheets
for the children
+ 1 booklet
for the parents

Microscope

9003

A binocular microscope to discover the microscopic world. Place objects from the house on the base, turn on the lamp and observe easily.

Contains child-friendly accessories: a x10 binocular microscope with LED lighting, tweezers, pipette and Petri dish.

4+

3
Not included

3

3 700802 101758



**MAX
ZOOM
10x**



10 illustrated experiment sheets
for the children
+ 1 booklet
for the parents



Buki
France

Mini Sciences

Product in development
artworks, contents and activities not final

Globe

9010

An illustrated 20 cm globe that turns in all directions, for children to discover the world !

The map includes more than 300 drawings: animals, monuments, sports, culinary dishes...

What are the rules of the game? Find the drawing on the globe as quickly as possible!

The child draws one of the 300 cards, observes the drawing, turns the hourglass over, and must find the drawing before the hourglass runs out!

On the back of each card, the child will discover an anecdote or information.

Diameter: 20 cm. Metal base.

Included: 300 double-sided cards, and illustrated instructions.



GLOBE JUNIOR



A 20 cm globe
with a base to turn it in
all directions!

300 cards
with drawings
on the front,
and information to know
on the back

Playful globe :
the child draws a card,
turns the hourglass over
and must find the
corresponding drawing!



Buki
France
BUKI Junior

Maths balance

5604

A balance to learn how to sort colours, weigh, and easily do maths calculations!

From the age of 3, children will be able to sort the tokens by colour by placing them in the matching coloured compartment. The instruction sheet includes counting exercises.

Then, they can learn about weights and balance using the two trays provided.

Older children will learn to count while playing! To find the solutions to the 60 puzzles, children must hang the weights to balance the scales and find the right answer! They can do all kinds of calculations: addition, subtraction, multiplication and division.

Included: a maths balance, 2 trays, 30 tokens in 6 different colours, 30 cards and an activity user guide for parents.



3+



Well done, that's the right answer!



Sort and count



Which is heavier?



Bingo junior

5602

Choose a card, designate a game master to do the draw, if the drawn ball appears on your card, place a token on it. The first to complete their grid wins the trophy!

10 double-sided grids, 30 balls and 60 tokens included.

3+



10 numbers,
10 animals and
10 colours



10
double-sided
cards



Step by step learning !

My first clock

5605

A clock with a system of questions and answers to help children learn to tell the time on both a clock face with hands and a digital dial.

Children choose a clock face and learn to tell the time step by step. The first ones show different times of day while the last one shows the whole clock face.

Once your child has learnt to tell the time they can insert the alarm unit inside the clock and they'll have a fully functioning clock - they can even set the alarm!

The clocks and dials help children learn to tell the time in both 24 hour and 12 hour (am/pm) formats.

Includes: 8 clock faces and dials, 100 questions/answers.



Learn to tell the time gradually with the different dials

Turns into a real alarm clock !



100 questions and answers



8 clock faces and dials for 24h clock
8 clock faces and dials for 12h clock (am/pm)



1

Put a card in



2

Say what time it is



3

Check your answer



BUKI Junior

Pick-up shapes

5606

Pick up the different shapes without touching the rim and see how many you can collect!

If the tweezers touch the metal rim of the tray, a light comes on and a buzzer sounds. Each shape comes in 3 different sizes, for 3 levels of difficulty.

There's a timer so that children can time themselves when playing alone. If two people are playing, the one to get the most shapes without sounding the buzzer is the winner.

Children learn the names of the shapes and colours as they prepare the cards with the stickers provided.



Develops fine motor skills



3 sizes = 3 difficulty levels

My writing tablet

5607

A tablet with LCD screen for learning to write the letters of the alphabet in capital letters and lower case cursive letters, as well as numbers from 0 to 9. Plus, learn to draw curvy and straight lines.

The child puts a sheet under the tablet and practices by tracing the lines on each sheet. Erase by simply pressing the button! Write using the stylus like a pen. Add the grip to learn how to hold the pen correctly. This grip can also be used on one of your own pens.

The tablet can also be used to draw and even copy other drawings thanks to the transparent screen.

The tablet weighs only 100g and is easy to carry. Dimensions: 22 x 14.5cm.

20 cards for a total of 40 sheets: 26 letters of the alphabet, numbers from 0 to 9, 4 sheets with lines.



Learn to write letters and numbers and draw lines!

40 sheets

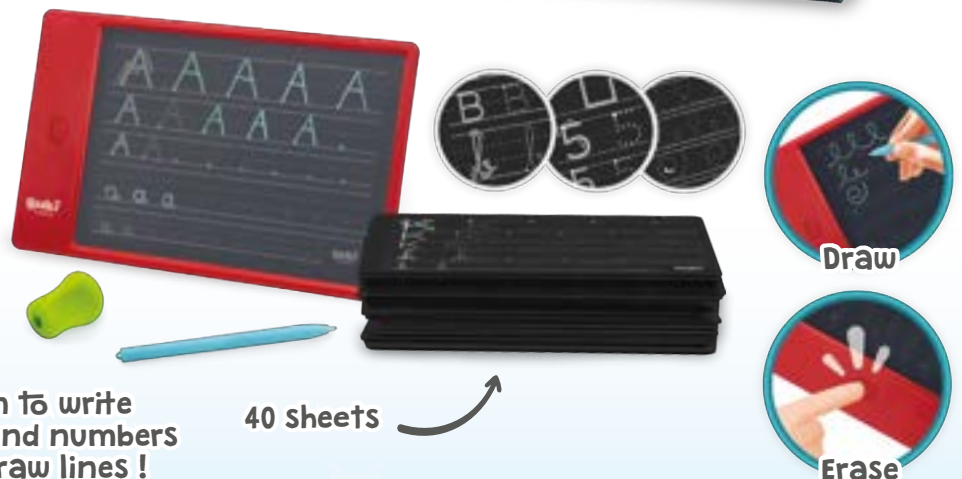

Draw

Erase

2.4GHz RC
Construction Truck



2 modes



Electric Screwdriver



radio control

Construction truck RC

9020

Assemble your truck with the screwdriver, following the step-by-step instructions.
 Two models: tipper and loader.
 Once assembled, switch on the motor and drive the truck via radio control.
 The screw-gun turns into a screwdriver and a radio control. Sound functions.



3 700802 103592



Lithium battery

2 models
 1 model at a time



Easy assembly

ASSEMBLE AND PILOT !

Waste truck RC

9021

Assemble your truck with the screwdriver, following the step-by-step instructions.
 Two models: waste truck and rubble tipper.
 Once assembled, switch on the motor and drive the truck via radio control. The screw-gun turns into a screwdriver and a radio control. Sound functions.



3 700802 103608



Fire truck RC

9022

Assemble your truck with the screwdriver, following the step-by-step instructions. Once assembled, switch on the motor and drive the truck via radio control.
 The screw-gun turns into a screwdriver and into a radio remote control so you can move your vehicle. Sound functions.



3 700802 104643



BUKI Junior

Cook Chef - Chocolate

7166

Make chocolate paste and use the press to make chocolate shapes in a range of flavours! You'll also be able to make chocolate bars, lollipops, and filled and surprise eggs with the equipment provided!
20 recipes are explained step by step in the illustrated colour instruction sheet. Chocolate not included.



20 recipes





Professional Studio Candles

5420

Create and decorate natural candles in stylish shapes using soya wax and cotton wicks! Special container with secure cover for safely melting the soya wax in the microwave.

6 moulds and 3 cutters for creating 9 different candle designs! Use diamanté, gold coloured pencil and coloured wax to personalise your candles. Wrap up a pendant and hide it in the candle for a unique gift!

Set includes: 1 station with 6 transparent moulds, 3 metal cutters, 1 cotton wick spool, 2 packs of soya wax, 5 pendants, 8 crayons, 1 pencil sharpener, 1 paintbrush, 5 tubes of glitter, 1 template.

7+



Professional Studio

900g of soya wax



Decorate your natural candles!



Professional Studio Candles Refill

5423

Use soya wax to create natural candles! You can melt this wax in the microwave or in a bain-marie! 8 coloured wax crayons and cotton wicks are also included.

The soya wax can be used with the set "Professional Studio Candles".
Weight: 750 g

7+



Professional Studio Pottery

5426

A real potter's wheel specially designed for children! The instruction sheet tells you how to make a bowl, a pot or even a plate that can then be decorated! 2kg of air-drying clay is provided. Two blocks of clay: one light-coloured, one brown.

The key to success? A cutter to measure out the amount of clay needed and centre it on the wheel to start the creation.

Once the piece has been created, simply move the drawer and place the tray there so that your creation can dry and then be decorated! While drying, the studio can be safely washed as it has a removable electric motor.

The potter's wheel only works with the EU mains adapter provided to ensure the correct motor power is applied.

Many accessories included for creating and decorating: 2 kg of clay, wooden and metal tools, glitter, diamanté, stamps, two brushes, tubes of paint, and more.

8+



3 700802 103509



If other mains adapter is required, please contact our team.

Wooden tools

2 kg of clay



A real pottery studio specially designed for children!



Leave to dry and then decorate!

Professional Studio Pottery Refill

5431

Use clay to create things on your potter's wheel.

One 500 g light-coloured block and one 500 g brown block, as well as a zip-up storage bag are provided. The clay air dries and does not require baking.

This clay can be used with the Professional Pottery Studio set. Weight: 1 kg.

8+



3 700802 104957



Professional Studio Engraving

5427

A safe workshop for engraving on wood and metal. Create and personalise 5 magnets, 5 key rings, 10 necklaces, and 1 bookmark!

The woodburning tool is equipped with a guard to prevent burns, a thermostat to adjust the temperature, and an ON/OFF key. Adults can use a pair of tweezers to safely attach one of the 6 tips to engrave different designs!

The metal engraver can be used to draw designs on metal plates that can then be turned into jewellery or key rings!

Many accessories included for creating and decorating: felt tips, glitter, diamanté, glue, pair of tweezers, metal and wood shapes, chains, rings, clasps, etc.

The woodburning tool works on AC power [EU plug], and the metal engraver requires 2 LR06 batteries, not included.



If other mains adapter is required, please contact our team.



A safe station for engraving wood and metal!



Professional studio Engraving Refill

5434

A refill for the Professional Studio Engraving Studio set, to create new engravings on wood and metal. Create and personalise 5 magnets, 5 key rings and 10 necklaces!

The accessories can be used with the «Professional Studio Engraving Studio» set (ref. 5427).

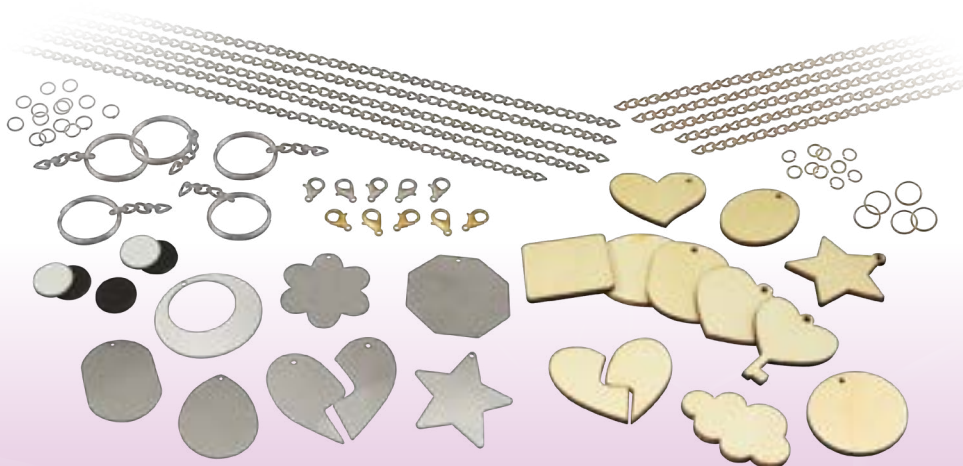

Professional Studio 3-in-1 light pad

5432

A portable light pad that can be used to draw, trace, and create comics and even flipbooks!

Drawing feature: Place a template on the pad, then a clean sheet of A5 paper on top. Use the LED light to trace the template – or just to light up your creation!

Comic/manga feature: Take a sheet, use the stencils to create blank comic book pages, then draw, add stickers and write your stories.

Flipbook feature: Place the adapter on the tablet.

The pad is portable and can be used flat with the 4 feet, tilted using the stand in the centre, or placed on your knees.

Paper size for comics and mangas: A5 - 21 x 14.8 cm.

Paper size for flipbooks: 11.4 x 6.5 cm.

A variety of accessories: 30 x A5 sheets, 100 sheets for flipbooks with a clip and a cover, 2 sets of stencils, 4 sheets of stickers, 1 case with 12 standard felt-tips, 12 brush pens, 12 watercolour pencils, 1 paintbrush, 1 gold gel pen, 1 silver gel pen, 1 fineliner pen, 1 pencil, 1 rubber, 1 ruler, 1 pencil sharpener.

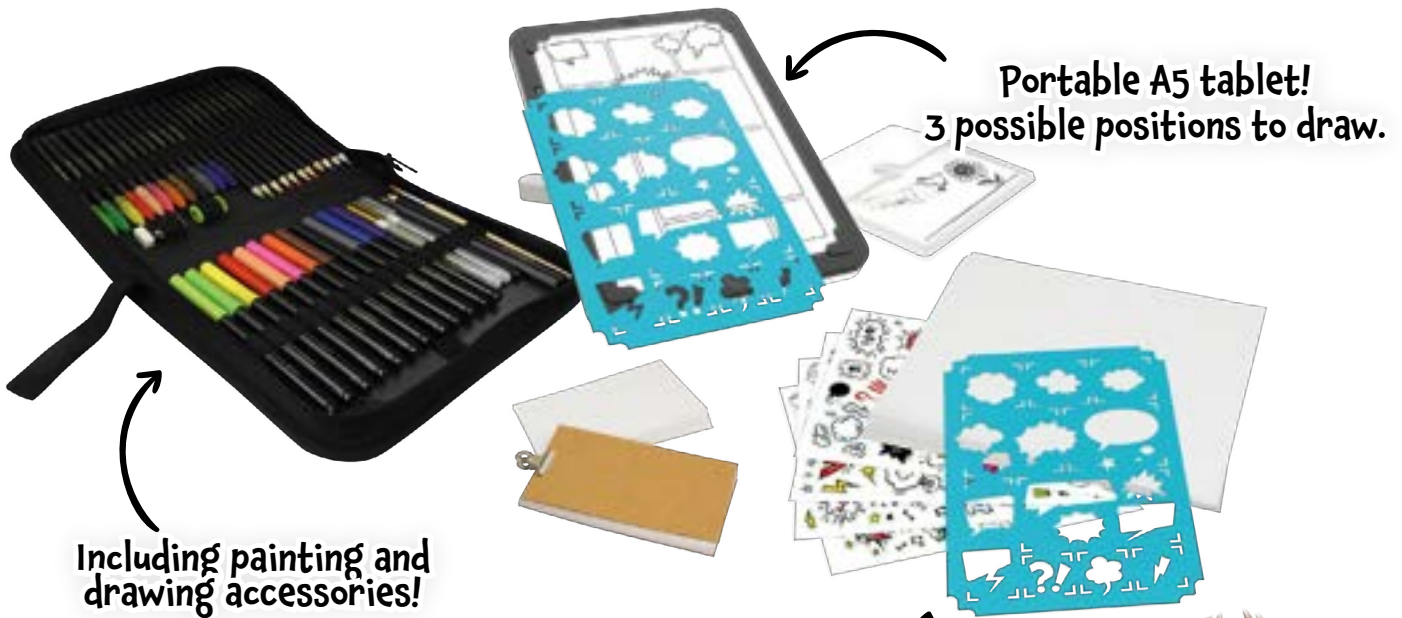

Including painting and drawing accessories!

Portable A5 tablet!
3 possible positions to draw.

Includes stickers and stencils to customise your comics

1

Trace and draw

2

Bring your drawings to life

3

Create comics and mangas



Professional Studio Beauty

5421

Make beauty products using cooking ingredients!

Use the mixer to prepare shampoo, lotions, masks and creams, then pour them into different bottles. Use pre-measured sachets to make bath bombs that you can personalise with dried flowers!

Discover 15 recipes and the benefits of the ingredients used in the instruction sheet with colour illustrations.

7+

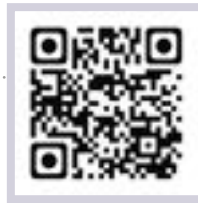

Professional Studio



Professional Studio Hair

5422

One professional styling head with highly realistic hair growth pattern. The head is fixed using a clamp so it won't move while the child is styling it. Over 15 real accessories included: brush, comb, hair clips, hair doughnut, headband, pink tie dye hair extensions and more.

30 hairstyles explained step by step in the illustrated instruction sheet! You can try out the different hairstyles on the doll, and then on yourself!

7+



Implanted hair



Professional Studio Make Up

5425

Learn make-up techniques with the instruction sheet and practice with your studio!

The instruction sheet will tell you which colour, texture or combination is best for your face shape or hair colour!

1 mirror and lots of storage to set up all the equipment: nail file, 2 brushes, 1 nail dotting tool and an orange stick.

High-quality makeup included: 4 nail varnishes, 3 glosses, 3 lipsticks, 2 eyeshadow palettes and 1 blusher palette.

7+



3 700802 103332



Mirror

Lots of accessories

Learn make-up techniques!



Professional Studio Nail Art

5404

A nail bar with a section for holding the finger you're working on, a section for drying your nails quickly, and a magnifying glass and light for precision work!

Choose your manicure from the 30 models on offer, copying them step by step for a professional result!

Many nail varnishes and accessories included: 8 varnishes (coloured, black, white, transparent), brushes, dotting tool, orange sticks, stickers, nail files...

8+



3 700802 101307



Professional Studio Nail Stamping

5433

Choose a stencil, add a drop of nail polish, pick up the design on the stamp and press it on your nail!

Use the 7 plates to create endless designs using over 100 patterns and letters.

Mix colours to create your own shades of nail polish. Add a drop of each colour to the tray and mix using the brush provided.

5 nail polish colours are provided, including 3 primary colours, white, and a clear nail polish to cover designs.



7
plates



More than
100 patterns!



4 varnishes
+ 1 top coat

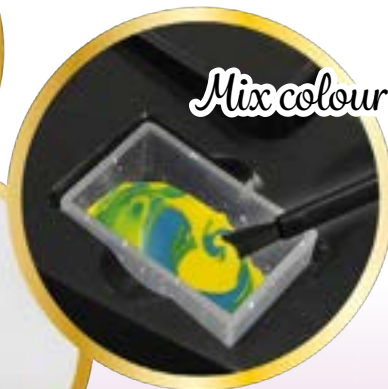
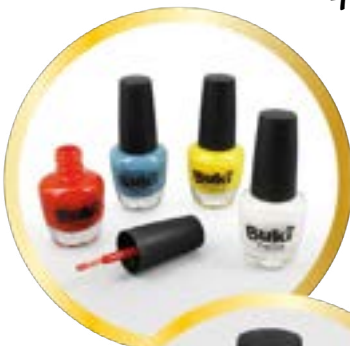

Mix colours!



Put a drop of polish



Pick up the design



Place it on your nail

Professional Studio Mode

5408

Choose a figure, design outfits with the stencils and then fill them out using the many different accessories included: self-adhesive fabric, feathers, glitter, felt, ribbons, felt-tip pens, watercolour pencils, scissors, a pencil sharpener, and more.
Draw inspiration from the portfolio to create your own trends!



3 700802 102168

Professional Studio

Pencils + watercolour pens

4 stencils to draw outfits, hairstyles and accessories

Store the accessories on the base

Create many trendy styles!

Professional Studio Mode - Refill

5413

A refill of self-adhesive materials for even more fashion studio projects!
10 adhesive fabric sheets (12 x 15 cm): 1 fur, 2 glitter, 1 imitation leather, 3 printed cotton, 3 felt, 6 assorted styles.



3 700802 102748



5414 - Wax



3 700802 102755



5415 - Marin



3 700802 102762



5416 - Liberty



3 700802 102779



5417 - Tropical



3 700802 102786



5418 - Fruits



3 700802 102793



5419 - Birds



3 700802 102809

Professional Studio Mode Deluxe

5428

A design studio for you to create your own look book of ladies' and men's fashion!

Switch the light on, put a stencil in and draw clothes on the figure outlines. Then decorate them with the self-adhesive fabrics, glitter and any of the many other accessories included. Slide the hairstyles, tops, bottoms and footwear you've designed into the book - just turn the pages and you can have a new look every day!

Many different accessories: magic felt-tips, self-adhesive fabrics, self-adhesive fabrics you can colour, water-colour pencils, LED light, 2 hole-punches, diamanté, ribbons and much more!



Watercolour pencils



Magic felt-tips



Buki
France
Professional Studio

Clip-on light

2 figure outlines

Fabrics to colour

Create your own looks!



Professional studio Spin Art

5430

A studio to create original works of art with paint and glitter!
 Place a sheet of paper on the board and a bottle of paint on the arm. Use one hand to press the button to spin the board. Use your other hand to move the removable arm and squeeze the bottle to squeeze out as much paint as you like!
 You can place a tube of glitter on the arm to decorate your creation.
 The board can be removed to make washing it easier!
 Use the crayon and the templates to mark out the areas where you don't want any paint.
 3 extra bottles of paint to mix your own colours!
 2 frames are included to display your creations.
 A variety of accessories: 30 paper cards in 5 different shapes, 8 paint colours, 3 empty bottles, 3 tubes of glitter, 2 frames, 1 crayon, 5 black templates and a guide.



7+



2 frames included!



A studio to create original works of art with paint and glitter!

Professional studio Couture expert

5409

A sewing machine to help you learn the basics of sewing and create 6 trendy projects: a bookmark, a key ring, a storage basket, a pouch, a purse and a pincushion!
 The speed of the machine is perfect for children, offering two automatic speeds and pedal mode. Users can choose between 12 different stitches, including zigzag stitch to oversew fabric. This machine has been specially designed for children, featuring a large work area, a needle guard, and easy threading and tension control! Each of the fabrics used in these projects has a different texture: fur, coated cotton, jersey, cotton, felt, and imitation leather.
 Several accessories, including metal spools and spare needles for the machine, are included. How to make the clothes and the basics of sewing are explained step-by-step in illustrated instructions featuring QR code links to video tutorials!



10+



Safe for children to use



Video tutorials!



The machine is powered by a EU-mains adapter (included). If other mains adapter is required, please contact our team.

Purse

5411

Make a small reversible purse with one patterned side and one solid-colour side!

Contents: fabric, clasp, elastic cord, needle, safety pin, headed pins and thread.



Creations can be made with hand stitching or using the Professional Studio sewing machine.



Professional Studio

Professional studio Couture

5410

The sewing machine that's perfect for beginners! Easy to handle, with two speeds and numbered tension settings!

Learn to sew with four trendy projects: bunting, a pincushion, a bow tie and hanging storage pockets!

Several accessories, including metal spools and spare needles for the machine, are included. How to make the clothes and the basics of sewing are explained step-by-step in illustrated instructions featuring QR code links to video tutorials!



The machine is powered by a EU-mains adapter (included). If other mains adapter is required, please contact our team.



+ 4 projects:

Bunting

Pincushion

Bow tie

Hanging storage pockets

A sewing machine like grown-ups use!

Video tutorials!



Use the pedal or automatic mode



Plastic finger guard for extra safety!



Metal presser foot and bobbins



Professional studio Drawing kit

5436

This drawing set provides children with all the materials they need to develop their creativity!

Children will be able to draw and paint their work in watercolours on the sketch pad provided.

The 2 refillable water brushes make it easy to paint with the 12 cakes of paint, and the crayons and pastel crayons are easy to use too.

The sketch pad slides under the elastic bands on the pencil case and all the materials are stored in the interior compartments. The case closes with a zip and the handle means you can take it anywhere!

The pack contains 12 cakes of paint, 24 double-ended felt-tip pens, 18 watercolour crayons, 8 oil pastels, 12 glitter gel pens, 1 HB pencil and 1 2B pencil and lots of accessories.

Size of case: 23 x 33 cm

Sketch pad: A4 - 35 detachable sheets - 300 g

6+



+70
accessories



Storage case
with a
carry handle





DIY - Water bottle

FK001

Decorate your water bottle to give it a unique look and take it to school or on a walk.

Pick your favourite stickers, customise them with the four tubes of 3D paint and stick them to your bottle.

Contents: one 400 ml bottle, a screw top cap, a carabiner clip to attach bottle, 2 sheets of stickers, 4 tubes of 3D paint.



3 700802 105145



50 Stickers



Drinking bottle made of stainless steel (400ml)

Carabiner clip



3D paint



Scoubidou

FK002

12 different scoubidou to make, plus some extra strings so you can design your own! Contains 55 strings altogether, including coloured, metallic, transparent and even glitter strings.

And when you've made all 12 items, you'll have 18 strings left over to try out your own ideas!

Contents: 55 assorted scoubidou strings, 15 key rings and 2 pencils.

Projects range from easy to more advanced. Each technique is explained step by step in the instructions, with diagrams for an easy learning.



12 designs explained step by step



Activity Box

FK003

A box of creative hobby supplies for children 4 years and up!

The box contains 2 storage trays to put on the table to have everything at hand.

The trays can be used to sort and store the various accessories.

Parents and children will be guided in their creations thanks to the instructions and its 20 projects with step-by-step explanations and illustrations. Cutting patterns are also provided for your convenience.

Children can make a bee, a windmill, a crocodile, a bookmark, a mask, a card with pompoms, and more!

Over 800 accessories are provided, including a pair of scissors, coloured paper, standard, giant or glittered pipe cleaners, cotton threads, wooden sticks, buttons, brass fasteners, felt, felt pen, paint, etc.

Instruction sheet with colour illustrations with 20 projects included.



2-in-1 projector

FK004

A projector with double functions:

- Drawing projector: project the image in black and white on the paper sheet to draw the contours and project the coloured image on the wall to give colour to your drawing!
- Images projector: remove the projector to hold it in your hand, and project images in your bedroom! Focus possible for better sharpness. The projector can be adjusted in height.

Many accessories are included: 30 images to reproduce, 8 watercolor pencils, 8 felt pens, a lead pencil, an eraser, a pencil sharpener, 2 brushes, 40 paper sheets with different sizes and thickness, 5 bookmarks and 1 poster...

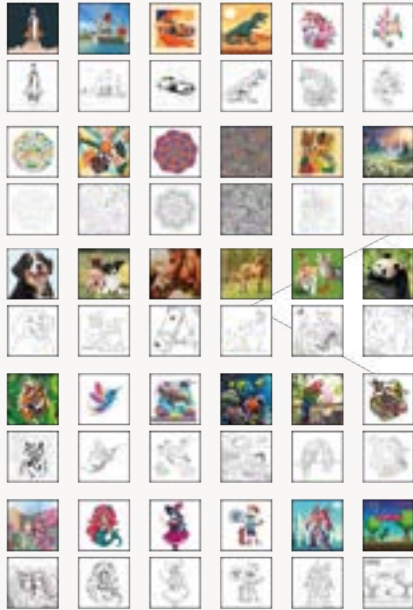

and draw!

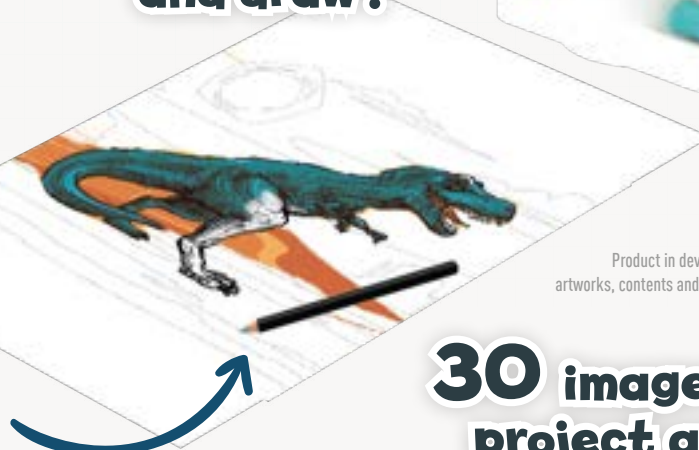

Product in development
artworks, contents and activities not final

30 images to project and reproduce



Project!



Rock Painting

FK005

10 real rocks to decorate to your heart's content!

Choose a rock and decorate it with the paint, design sheet or markers.

You can hide the rock somewhere you like for another child to find or decorate your bedroom with it!

Contains: 6 rocks of 5-7 cm, 4 rocks of 3-5 cm, wooden stand, brush, paint, adhesive eyes, decals, ice-lolly stick.



Imagine!
Create!



Be TEENS



Wrapped bracelets

BE303

Wrap the cotton threads, add rings and charms for colourful bracelets!

8+



String art

BE304

Weave the threads on the inserts to create earrings with vivid colours!

8+



Be teens

Wrap bracelets

BE201

Wrap waxed and cotton threads around beads to make beautiful bracelets!

8+

12/6

3 700802 101413



Sparkling bracelets

BE204

Customise 3 bracelets with ribbons, lace, diamantés and glitter.

8+

12/6

3 700802 101468



Glitter tattoos

BE205

Choose your design, decorate it using the glitter, and stick your tattoo on your skin for a trendy look!

8+

12/6

3 700802 101857



Buki
France

Be teens

Wax print jewellery

BE208

Make 4 pieces of jewellery with wax print fabric!
Tie, weave, glue and sew accessories to create trendy jewellery.

8+

12/6

3 700802 102519



Kawaii jewellery

BE210

Four pieces of kawaii-inspired jewellery using charms, ribbons and coloured knots!

8+

12/6

3 700802 103172



Buki
France

Be teens

Charm bracelets

BE101

Design and make 6 trendy bracelets using colourful beads that come in a variety of shapes and effects.

8+

12/6

3 700802 101352

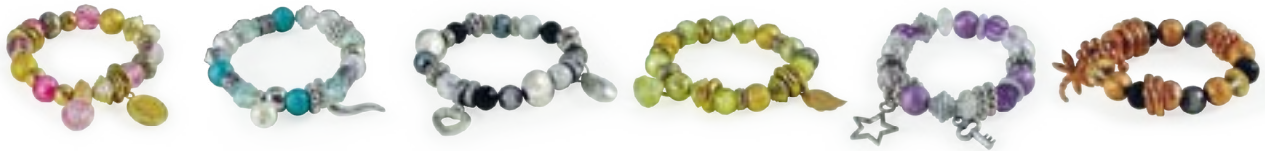

Be teens

Friendship bracelets

BE102

Make 10 trendy bracelets using cotton thread, beads, and charms! Use the foam wheel or sucker to hold your bracelet in place while you get creative.

8+

12/6

3 700802 101369



Glitter jewellery

BE105

Choose your beads and glitter, mix colours and fill the tubes to transform them into jewellery!

8+

12/6

3 700802 101390



Woven jewellery

BE106

Use the Brick Stitch technique to weave jewellery and accessories using coloured beads!

8+

12/6



Bead tattoos

BE107

Choose your design, decorate it using the mini-beads, and stick your tattoo on your skin for a trendy look!

8+

12/6



Bohemian jewellery

BE108

Mix and match different bead colours and styles and add charms and tassels to make bohemian-inspired jewellery.

8+

12/6



Buki
France

Be teens

Tassel jewellery

BE109

Create colourful tassels by winding thread and use accessories to make 8 trendy pieces of jewellery – earrings, necklaces, bracelets and more!

8+



Dreamcatcher jewellery

BE114

Make 5 lovely pieces of jewellery using the dreamcatcher technique. Weave each one, then add some feathers, beads, chains and charms to make your own unique piece of jewellery!

8+



Buki
France
Be teens

Jewellery vials

BE115

Fill, assemble, and customise the vials to create original and trendy jewellery! Pour glitter, microbeads, charms, and even origami into the vials to create unique jewellery. Makes 3 necklaces, 2 pairs of earrings, and 1 bracelet.



Unicorn jewellery

BE116

Create 5 trendy pieces of unicorn jewellery. Thread, prepare and assemble the beads and charms! Make 2 necklaces, 1 pair of earrings, and 2 bracelets.



Sparkling jewellery

BE117

Apply glue to the metal charms and sprinkle the coloured glitter on top to make 5 sparkling accessories!

Create 3 necklaces and 2 bracelets.



Magic jewellery

BE118

Assemble and create your own jewellery with beads, ribbons and charms that change colour depending on the temperature of your skin!

Create 2 necklaces and 3 bracelets.



Friendship bracelets

BE119

Try out different weaving techniques to create 10 trendy bracelets you can gift to your friends. Comes with a variety of accessories: cotton thread, waxed thread, charms and a faux leather bracelet. Use the foam wheel or sucker to hold your bracelet in place while you get creative.



Shrink Plastic jewellery

BE120

Use the coloured pencils to colour in the shrink plastic pendants and charms and turn them into jewellery! When heated in the oven, the plastic shrinks and hardens into solid plastic that you can use to create the 7 pieces of jewellery.

A variety of accessories: 4 sheets of shrink plastic with pre-cut shapes with holes, 9 coloured pencils, rings, chains, clasps and more.



Charm jewellery

BE121

Fill in the metal charms with paint and create colourful jewellery! Paint dries naturally. Make 2 necklaces, 2 bracelets and a pair of earrings.

Contains: metal charms, tubes of paint, ribbon, tassels, beads, chains, etc.



Shell jewellery

BE122

Weave the threads, add some beads and gold paint, to create 6 items of jewellery from shells!

Make 2 necklaces, 3 bracelets and a pair of earrings.

Contains: assorted shells, gold paint, ribbon, tassels, beads, charms, chains etc.



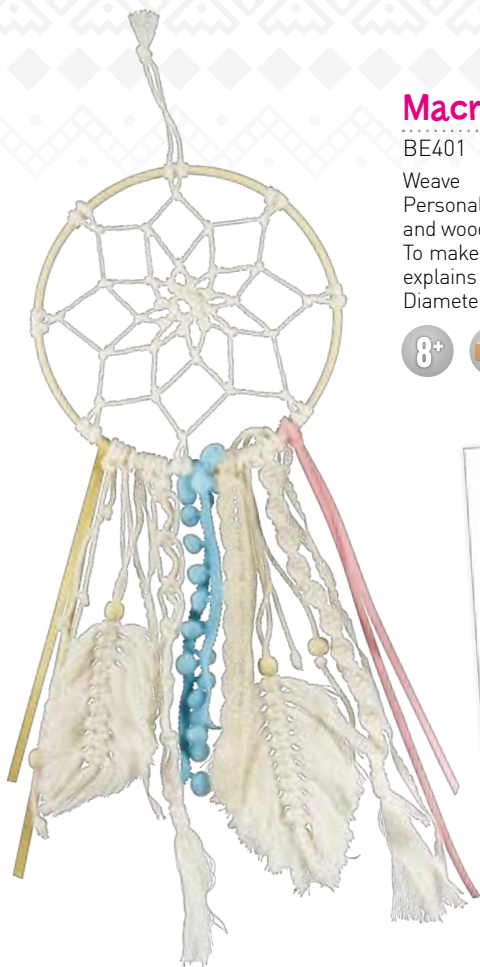

Macramé dreamcatcher

BE401

Weave a dreamcatcher using the macramé technique. Personalise it using ribbons, pompoms, weaving techniques and wooden beads!

To make it easier, the detailed and illustrated instruction sheet explains the different knots used in macramé. Diameter of the dreamcatcher ring: 19 cm



Deluxe friendship bracelets

BE402

Weave 15 unique, colourful Brazilian bracelets using cotton thread!

The suggested patterns get progressively more difficult and the instruction sheet has diagrams that explain how to create lovely designs.

Included: a weaving card with measurements to show the current weave length and a foam wheel for round bracelets.



Included:
a weaving card!



15
weaving
bracelets with
progressive
difficulty
levels



Buki
France

Be teens

My pretty bag

BE403

A set with real make-up and accessories to make 3 pieces of jewellery!

Follow the instructions to make 2 bracelets and a necklace. Then keep them in the little pouch.

Two eyeshadow palettes including one with glitter, a blusher palette and a shiny lip gloss are also included.

Store your make-up and jewellery in the bag and take them everywhere with you!



A pretty bag !

+

real
make-up



+ 3 pieces
of jewellery
to make !



Be teens

Bead loom

BE001

Inside you'll find a bead loom and all the materials you need to weave 15 trendy bracelets!

More than 10 000 beads and 25 sheets you can put into the guide, including 10 with patterns and 15 you can draw on to create your own designs!

8+



3 700802 101543

10 000 beads

Tilting



10 sheets with patterns
+ 15 sheets to create
your own patterns



10 bracelets to reproduce and
5 bracelets to invent!



Knitting

BE002

Learn to knit a scarf, a pouch, and fingerless gloves!

Learn in 3 steps: finger knitting, knitting with needles and changing colour, and knitting using stocking stitch.

8+



3 700802 101550



Buki
France

Be teens

Mega Bracelets

BE003

A kit to make 20 trendy bracelets including Shamballa bracelets, ribbon bracelets, friendship bracelets, charm bracelets, and more...

A watch face is included so you can weave the straps!



20
bracelets
including
1 watch face



Be teens

Knitting mill

BE005

Learn to knit a pair of slippers, a headband and a scarf using circular knitting mills. Each knitting mill is numbered to make it easier for you to use!

The instruction sheets given for each project feature colour illustrations and plenty of diagrams.



Numbered
knitting mills!



Sparkles

DP101

Using the pen, peel off the paper following the numbers and then squeeze out the glitter to create unique pictures!

3 models available in assortment: unicorns, fairies, butterflies & bird.

Each box set contains 4 pens filled with 4 different glitter colours. The tool allows for the paper to be peeled off section by section for accuracy.

The body of the pen is soft to allow you to easily squeeze out the glitter onto the sticky areas!

Two picture boards and a wooden frame included in each kit. Once the pictures have been completed, the child chooses which one they would like to place in the frame.

Picture size: 10 x 14 cm.

5+

24/6

3 700802 103189



Peel off the paper,
and squeeze out
the glitter with
the pens!



DP102
Unicorns

only available in assortment

DP103
Fairies

only available in assortment

DP104
Butterflies

only available in assortment



more than
600
diamanté

Glitters

DP001-DP005-DP009

Find the matching numbers and letters to guide you in placing the diamanté on the self-adhesive board!

9 designs: unicorn, lama, toucan, dreamcatcher, mandala, Mexican skull, koala, panda and peacock.

The wax typ stylus helps you to pick up the diamanté and place it on the self-adhesive board easily.

3 sizes of diamanté with a matt or shiny look for added originality!

Once the diamanté is stuck on the board, the child places the painting in a pretty white wooden frame, included. Size of the frame: 10 x 14 cm.



7+

Assortment 1

DP001



DP002
3 700802 102571



DP003
3 700802 102588



DP004
3 700802 102595

Assortment 2

DP005



DP006
3 700802 102618



DP007
3 700802 102625



DP008
3 700802 102632

Assortment 3

DP009



DP010
3 700802 103943



DP011
3 700802 103950



DP012
3 700802 103967



Be teens

Secret book

NB003

A notebook with 120 decorated pages where you can record your secrets. The notebook closes with an included code padlock. Stick the diamanté on the numbers, letters or symbols to customise the cover of your secret notebook!

Use the stickers and the gel pens with glittery, metallic and neon effects to write and decorate. Write secret messages with the UV pen's invisible ink and use the UV light on the cap to reveal the message!

A5 notebook - 120 pages.

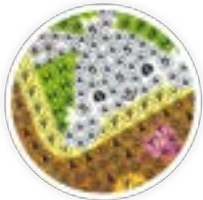

8 gel pens
+
1 UV pen



Scratch notebook

NB001

A notebook with scratch cards!
Write or draw with the wooden pen to discover the colours.

Included: 150 sheets (grammage: 210g, size: 8,5 x 8,5cm) and a wooden pen.



Secret notebook

NB002

Write a secret message with the invisible pen and use the UV light on the cap to read it!

Set includes: one 300-sheet self-adhesive notepad and an invisible ink pen with UV lamp.



Buki
France

Be teens

Fashion sketchbook

CM100

Create and draw your own unique outfits! Use the self-adhesive fabrics to bring your designs to life!

Draw clothes using the templates then add stickers to accessorise. 4 coloured pencils, 4 double-ended felt-tip pens and 24 paint discs included. Sketchbook dimensions: 14 x 18,5 cm. Sketchbook containing 28 thick pages, with 6 pages of outfits to colour in and 22 pages of figure outlines.

3 models available: princess dresses, evening dresses and rock outfits.

6+

24/6

3 700802 103561



CM101

Princess dresses

3 700802 103288



CM102

Evening dresses

3 700802 103295



CM103

Rock outfits

3 700802 103301



DIY Pen - Assortment

STYL01

Fill the pen with glitter, sequins and microbeads then add water! Add a super soft tassel for the finishing touch!

Several shapes and colours are available in the kit so you can create a truly unique pen. There's plenty of choice so you can change whenever you want!

2 spare leads included.

3 models available: unicorn, flamingo and pineapple.

5+

24/12

3 700802 103523



STYL02
DIY Pen - unicorn
only available in assortment

STYL03
DIY pen - flamingo
only available in assortment

STYL04
Pineapple Pen
only available in assortment



Buki
France

Be teens

Drawing tablet

TD001

Write, draw or take notes on this drawing tablet with LCD screen. Write using the stylus like a pen. Erase by simply pressing the button!

A small button on the back enables you to lock the drawing so it does not disappear.

The tablet weighs only 100g and is easy to carry.

Dimensions: 22 x 14,5cm.



Drawing tablet XL

TD002

Write, draw or take notes on the large format drawing tablet with LCD screen.

Write using the stylus like a pen. Erase by simply pressing the button!

A small button on the back enables you to lock the drawing so it does not disappear.

The tablet weighs only 340g and is easy to carry.

Dimensions: 25,8 x 32 cm



Draw



Erase



Start over!



Hang up your pen

Buki
France

Be teens

Beads - 8 assorted styles

PE001

A set of five colours of beads.
Each tube contains 15 g of beads. The beads have a diameter of 2 mm.

5+

48/16

3 700802 103806



PE002

3 700802 103813



PE003

3 700802 103820



PE004

3 700802 103837



PE005

3 700802 103844



PE006

3 700802 103851



PE007

3 700802 103868



PE008

3 700802 103875



PE009

3 700802 103882

Accessories for jewellery

PE010

A set of accessories to create jewellery.
The bag contains: 1 spool of elastic thread (10 m), 1 fine needle, 10 silver clasps, 20 silver rings (6 mm), 10 gold clasps, 20 gold rings (6 mm).

5+

120/12

3 700802 103899

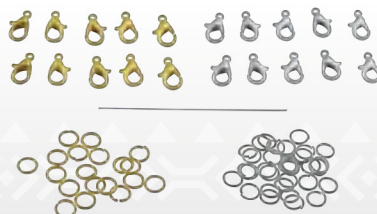

Buki
France

Be teens

Box of coloured beads

A box with 18 colours of beads of 2 mm in diameter. Choose the beads, and mix the colors to create trendy jewellery!
The storage box will allow you not to mix colours!
Each compartment contains 28g of beads.



Opaque

PE011



3 700802 103905

Transparent

PE012



3 700802 103912

Box of metallic beads

PE013

A box with 10 colors of metallic beads of 2 mm in diameter. Choose the beads, and mix the colors to create trendy jewelry!
The storage box will allow you not to mix colors!
Each compartment contains 38g of beads.



3 700802 103929



Box of wooden beads

This box features 13 different kinds of wooden beads!

It has beads in pastel, gold and silver colours and even some with letters on them. Pick your beads and mix 'n' match the styles and colours to make pretty jewellery everyone will love.

Use the storage box to keep your beads separated.

This box contains 90 g of beads.



Natural

PE014



3 700802 104537



Colours

PE015



3 700802 105121

75 wash-off tattoos

TA001

Choose a design from among the 75 tattoos available, and apply it to your skin with a damp cloth!

The tattoos are temporary and can wash off.

3 assorted styles: metallic tattoos, coloured tattoos and glitter tattoos.

Each model contains 2 sheets for a total of 75 tattoos. The number of tattoos can vary depending on how they are cut out.

8+



3 700802 102649



TA002 - Metal

3 700802 102656



TA003 - Coloured

3 700802 102663

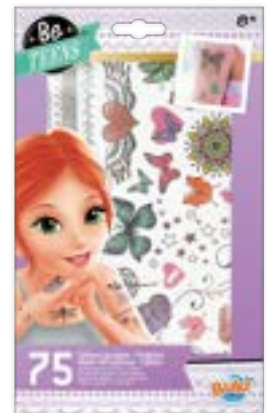

TA004 - Glitter

3 700802 102670



75 wash-off tattoos

TA006

Choose a design from among the 75 tattoos available, and apply it to your skin with a damp cloth!

The tattoos are temporary and can wash off.

Contains 2 sheets for a total of 75 tattoos. The number of tattoos can vary depending on how they are cut out.

6+



3 700802 103035



Buki
France

Be teens

CAMERA

IMPRIMANTE THERMIQUE INTÉGRÉE
BUILT-IN THERMAL PRINTER



Camera Built-in thermal printer

PV07

A camera with a built-in printer to preserve your best memories so they can be cherished forever. Black and white, ink-free printing with thermal technology.

3 paper rolls included. You can print 100 photos with the 2 standard rolls and 20 stickers with the sticky roll. Photo size: 7 x 5.5 cm.

A 8GB micro SD card is included to save your photos and even make videos.

With the dual lens, you can also take selfies, apply filters or even enable the flash!

Features:

- 2-inch colour screen
- Dual lens
- 2x digital zoom
- Fill flash
- Rechargeable (3.7V lithium battery)

Included: neck strap, USB-C charging cable, 2 standard paper rolls, 1 sticky paper roll, user guide.

Paper refills sold separately.



INK-FREE



INCLUDED



PHOTO/VIDEO

Instant print camera - Refill

PV08

3 standard paper rolls and 3 sticky paper rolls for printing photos with the Buki Built-in Print Camera.

You can print 50 photos (5.5 x 7 cm) with a standard paper roll and 20 photos with a sticky paper roll.

With this set, you can print 150 standard photos and 60 sticky photos!

Paper roll dimensions: 57 x 25 mm.



CAMCORDER

CAMESCOPE



Camcorder

PV09

A digital camcorder easy to handle so that the child can immortalize its most beautiful memories in video or photos!

The camcorder is compact, light (300g), and easy to hold thanks to its adjustable handle. The 7.5 cm diameter HD colour screen can be rotated, which allows you to turn the screen and switch to selfie mode.

The camcorder has a x16 zoom. The child can connect the camcorder to a computer to use it as a webcam. A fill-in flash is included to improve video quality in the dark.

A 16 GB SD card is included, to film up to 45 minutes in 1080p. Photo quality is up to 24 megapixels. The menu of the camcorder allows you to select the different resolutions.

Included: a 16GB SD card, pouch, remote control, strap and USB-C charging and transfer cable. A microphone jack and a slide are provided, if the child wants to add a flash or an additional microphone.



visual not final



Be teens



ROTATING HD SCREEN!

3 INCH / 7.5 CM



COMPACT AND LIGHT CAMCORDER!



FLASH TO FILM IN THE DARK!



Marbles run

PM854

Assemble the pieces to build the maze and launch the marble with the catapult!

Move the various elements and traps to set the marble's course and prevent it from falling.

Instruction sheet with colour illustrations with 4 labyrinth examples.

7+



3 700802 102175



compatible with



PM858

PM852



Direct the marble

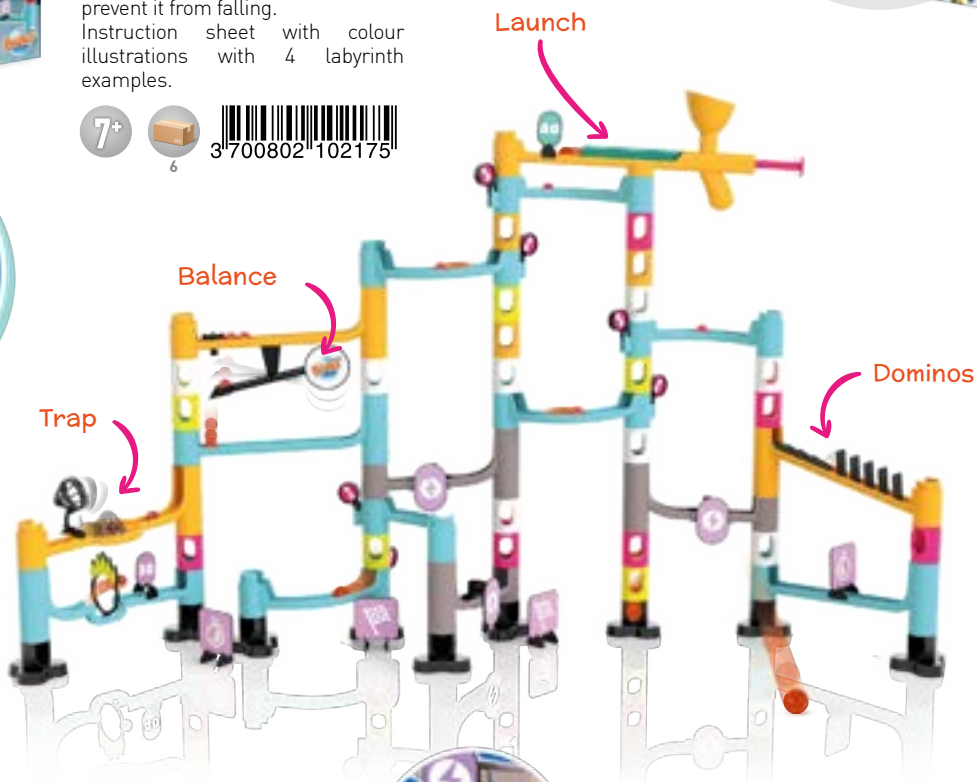

Mega Marble run

PM852

Assemble the labyrinth, then activate the different parts to set the marble on the right path so it doesn't fall!

Put the two modules wherever you want the marble to set off sound and light!

The marble lift is 60 cm high with 2 playing speeds.

Instruction sheet with colour illustrations with 6 labyrinth examples.

7+

3 AAA
Not included



3 700802 101611



Lift 2 speeds

2 sound and light modules

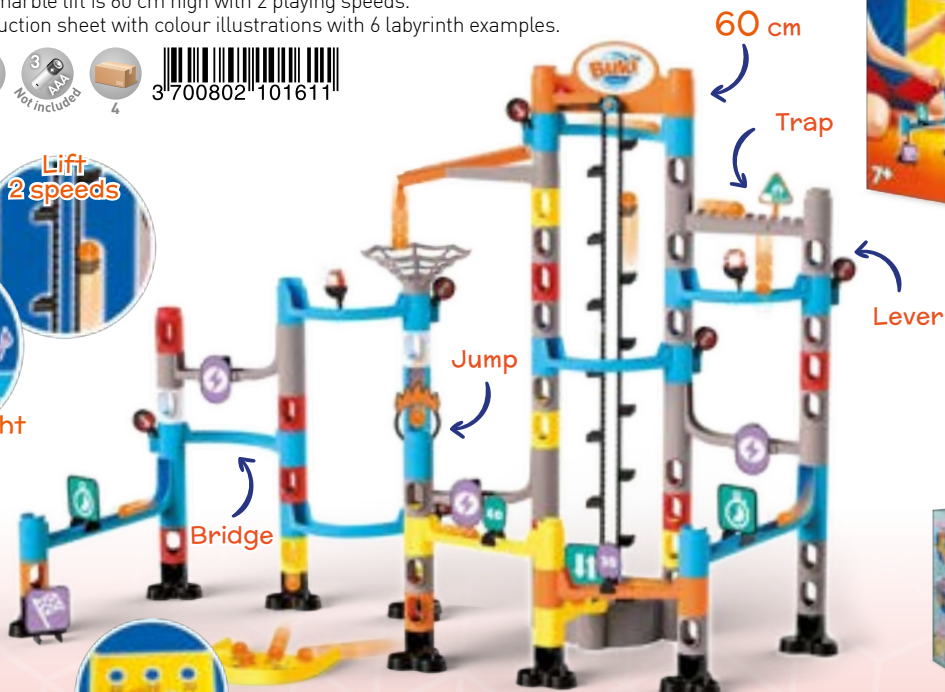

60 cm

Trap

Jump

Bridge

Lever

compatible with



PM854



PM858

Score points!



Marbles challenge

PM858

Assemble the maze, choose your coloured marble and put it on the starting line next to the competitors. Watch your marble race through the course and take on the traps! Use the bellows to speed up or slow down your marble. Who will win the race? Instruction sheet with colour illustrations of 5 different labyrinth models.

7+



3 700802 104124



Buki
France

Mazes &
Marbles

compatible with



PM854



PM852



Space odyssey

PM517

A 59 cm high marble run for the bigger kids!

A lift allowing marbles to easily reach the top of the constructed maze. Several models available with the possibility to create your own mazes.

Introduce children to building and let their imaginations take over.



0 870523 005178

..... 59 cm

Lift

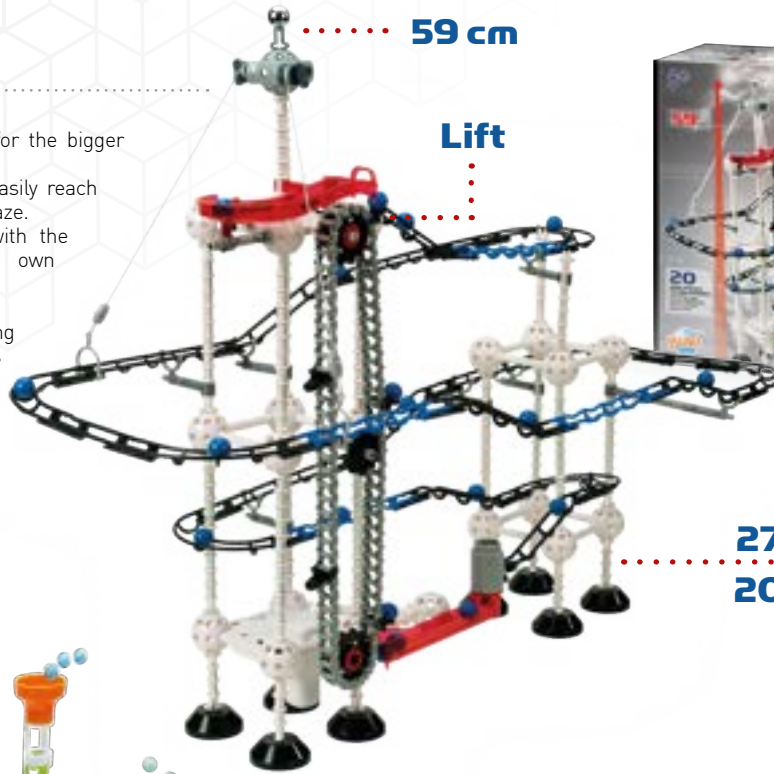

..... **270 pieces**
20 marbles

Marble runs

BU220

A marble run that you can build for hours of fun!

Join corner pieces and tubes, add turnstiles, levers and wheels to build fun and unique marble runs.

80 pieces, including 10 marbles. Instruction sheet with colour illustrations with 5 examples of mazes to build.



5+



0 870523 000869

Marbles shooter

PM857

Place a marble into the shark's jaw. Press on the button to activate the shooter to shoot out the marble and knock out the targets.

Contains a shooter in the shape of a shark, two double-sided targets and 8 coloured marbles.



3 700802 103516



Box of 56 marbles

PM856

A box of 56 glass marbles in 2 sizes and different styles.



3 700802 102694

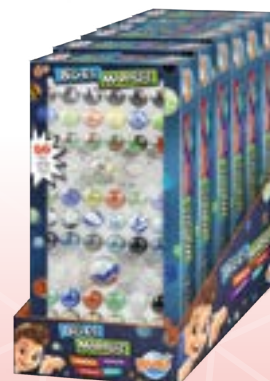

Box of 150 Flat marbles

PM859

A set of 150 flat marbles for playing in the playground or garden!

Five different styles of marbles: opaque, frosted, with glitter, clear and even glow-in-the-dark.



GLOW IN THE DARK



Box of 163 marbles

PM855

A box of 163 glass marbles in 4 sizes and 10 different styles. Check the back of the box for two game ideas!



GLOW IN THE DARK



My magic show

6060

A magic set with everything you need to become a real magician! Comprises 20 magic tricks that are explained step by step in the instruction sheet.

The 24 cards provide the child with different scenarios for putting on a magic show.



PUT ON YOUR SHOW!



24 scene cards with staging indications and dialogue



Buki
France

Mazes &
Marbles

Buki
France

Magic

Mini projector

Display 18 pieces - 3 assorted models
Ocean/Wildlife/Space

63010

A mini projector to display beautiful pictures on a wall or ceiling. Each mini projector comes with 3 disks of 8 slides each.



Each style can be ordered separately

6302ANI



6302OCE



6302SPA



Mini Projector Dinosaurs

6302DIN

A mini projector to display beautiful pictures on a wall or ceiling. The mini-projector comes with three discs of eight slides on the theme of dinosaurs.



NIMBLE FINGERS

54002

A game of observation, logic and dexterity that challenges you to recreate the pattern on the cards as quickly as possible!

By sliding the balls around with your fingers, copy the pattern on the card – either by yourself or against an opponent – as quickly as possible and without making any mistakes.

Contents: rules of the game, 14 cards and 2 abacuses. 1 or 2 players.



MEMORY GAMEPAD

6209

Observe and reproduce the sound and light sequences without making a mistake! What will be your best score? Challenge your friends and beat the record!

Number of players: 1.



BRAIN BUSTER - BEGINNER

6206

Discover 3 traditional puzzles, revisited for you to begin easily: three-way lock, nine small links and the locked ball. There is only one way to unlock them. Find the secret mechanism to take them apart, then find the solution to reassemble them! Challenge your friends and be the fastest. Includes: instructions and solution videos.



BRAIN BUSTER - EXPERT

6207

Discover 3 puzzles specially designed for experts: the Kong Ming sphere, the blossom lock and the Grandmaster's lock. There is only one way to unlock them. Find the secret mechanism to take them apart, and then find the solution to reassemble them. Challenge your friends and be the fastest. Includes: instructions and solution videos.



TRAVEL GAMES TABLET

6208

A tablet with an LCD screen, to play the most famous games on your own or with a friend. Play endlessly, and simply erase by pressing the button!

10 double-sided cards are included, for a total of 20 games: hangman, tic-tac-toe, battleships...

2 stylus are included: 1 or 2 players!

The pad is lightweight and practical to play on public transport or on the sofa for example!



1 - 2
PLAYERS



17.5 cm
x
23.5 cm



Handwriting practice lines consisting of 25 horizontal dotted lines.



Handwriting practice lines consisting of 25 horizontal dotted lines.





FIND US ON

Buki France



BUKI France

38 av. François Mitterrand
72000 Le Mans - FRANCE

Tél: +33 1 46 65 09 92

e-mail : alambert@bukifrance.com

www.bukifrance.com

